



Original Saw Company
465 Third Ave SE
Britt, IA 50423 USA

PH 641-843-3868
800-733-4063

customerservice@originalsaw.com
www.originalsaw.com

Getting Started

Unpacking, general machine precautions, wiring, installation, preventative maintenance.

Operations & Maintenance Manual

This manual is provided for your convenience in the use and care of your saw. These instructions include operation, precautions, preventative maintenance and other pertinent data to assist you in assuring long life and dependable service from your saw.

WARNING: FOR YOUR SAFETY READ AND UNDERSTAND THIS MANUAL PRIOR TO USING THE SAW. REVIEW ALL SAFETY RULES AND OPERATING INSTRUCTIONS FREQUENTLY.

RADIAL ARM SAW TYPE 6 - cross cut only

14" models 3531-01, 3536-01, 3531-03, 3536-03
16" models 3541, 3546

For Serial number 20220704461 forward
(September 2022)

TABLE OF CONTENTS

SECTION	PAGE
Warranty Information	2
Service Record	3
Power Tool Safety	4
Use / ANSI Conformity	5
Use / Preventative Maintenance	6
Symbols / Decals	7
Decal Locations	8
Saw Components and Controls	9
Product Specifications	10
Saw Assembly and Installation	12-15
Electrical Connections	11-13
Arbor Rotation	13
Changing Motor Voltage	13
Blade Mounting	15
Operating Instructions	16-17
Alignment and Adjustments	18-21
Troubleshooting	24-26

Industrial Use Warranty Information

Your new Original Radial Arm Saw is precision manufactured under strict quality standards. In the unlikely event there is trouble with your machine, the Original Saw Company warrants the machine for the period of one year from the date of purchase. The warranty covers defects in materials and workmanship. We will cover the cost of the defective part and ground shipping. If a replacement part is sent under warranty the defective part must be returned to Original Saw Company or you will be charged for the replacement. The part must also be accompanied by a return goods authorization number. This number can be obtained by calling customer service at 1-800-733-4063. When the part is returned it may be repaired or replaced at our discretion. The part must be shipped prepaid to: The Original Saw Company, Attn. Warranty Replacement Counter, 465 Third Avenue SE, Britt, Iowa 50423.

POWER TOOL SAFETY



GENERAL RULES FOR SAFE OPERATION OF POWER TOOLS

1. **KNOW YOUR POWER TOOL.** Read the owner's manual carefully. Learn the applications and limitations as well as the specific potential hazards of the tool.
2. **GROUND ALL TOOLS.**
3. **KEEP GUARDS IN PLACE.** Keep guards in working order.
4. **KEEP WORK AREA CLEAN.** Cluttered areas and benches invite accidents.
5. **AVOID DANGEROUS ENVIRONMENTS.** Don't use power tools in damp or wet locations. Keep work area well lit.
6. **KEEP CHILDREN AWAY.** All visitors should keep a safe distance from the work area.
7. **DON'T FORCE TOOL.** The tool will do a better job if used at a normal cutting rate do not force.
8. **WEAR PROPER APPAREL.** Loose clothing, gloves or jewelry may get caught in moving parts. Rubber footwear is recommended when working outdoors.
9. **USE PROTECTIVE GLASSES.** If operation is dusty also wear a dust mask.
10. **DON'T OVER REACH.** Keep proper balance and footing at all times.
11. **MAINTAIN TOOLS WITH CARE.** Tools kept sharp and clean provide the best and safest performance. Follow instructions for lubricating and changing accessories.
12. **DISCONNECT TOOLS FROM POWER SOURCE.** When not in use, before servicing, when changing accessories, blades, or cutters, the tool should be disconnected and locked out.
13. **REMOVE ADJUSTING KEYS AND WRENCHES.** Make it a habit to ensure keys and adjusting wrenches are removed prior to starting tool.
14. **USE RECOMMENDED ACCESSORIES.** Consult your distributor or Original Saw Company for recommended accessories. Using improper accessories may cause hazards.
15. **SECURE YOUR WORK.** Use clamps or a vise to hold work when practical.
16. **NEVER LEAVE TOOL RUNNING WHILE UNATTENDED.**

Use and ANSI Declaration

Intended Use of Machine

- Machines for Wood and plastic cutting only
- Maximum size of material
- 3531-01 3531-03 width 16" / 400 mm
thickness 4 1/8" / 100 mm
- 3536-01, 3536-03 width 24" / 600 mm
Thickness 4 15/16" / 125 mm

Residual Risks



The following risks are inherent to the use of radial arm saws:
In spite of the application of the relevant safety regulations and the implementation of safety devices, certain residual risks cannot be avoided.

These are:

- Impairment of hearing.
- Risk of accidents caused by contact with the uncovered parts of the rotating saw blade.
- Risk of injury when changing the blade.
- Risk of pinch hazard between bevel stop and carriage of machine.
- Health hazards caused by breathing dust developed when sawing wood, especially oak, beech, MDF.

Dust / Chip Collection



End user must ensure that the machine is installed in a well ventilated area with chip and dust extraction system fitted to the extraction points

- The machine is set for indoor use only and must be connected to a dust/chip collection system.
- The dust collection system must be switched on before cutting operations can begin.
- The hoses on the dust collection must be grounded.
- There are dust collection shrouds available as accessories please call customer service at 641-843-3868 or email customerservice@originalsaw.com with any questions

Eye Protection

- Eye protection must be worn at all times during use.

Trip / Slip Hazard

- Make sure power cable is routed in a manner to ensure there is no trip / fall or a slip hazard
- Keep work area around saw clean and free of hazards.

ANSI-Declaration of conformity

3531-01-230, 3536-01-230, 3531-03-208/230, 3536-03-208/230, 3531-03-460, 3536-03-460, 3531-03-575/600, 3536-03-575/600

Original Saw declares that these power pools have been designed in compliance with ANSI Machine Standards 01.1-2013. For more information, please contact Original Saw at the address below or refer to the address on back of the manual.



Noise Exposure

It is the responsibility of the installer and end user to ensure The Noise Exposure requirements of 29 CFR 1910.95 are satisfied.

3531-01-230, 3536-01-230, 3531-03-208/230, 3531-03-460, 3531-03-575/600, 3536-03-208/230, 3536-03-460, 3536-03-575/600

LpA (sound pressure) dB(A)* 85.5 85.5

LWA (acoustic power) dB(A) 93.5 93.5

* at the operator's ear

Take appropriate measures for the protection of hearing if the sound pressure of 85 dB(A) is exceeded. Note: sound levels will vary depending on material being cut and what blade is installed on the machine.

Original Saw Company
465 Third Ave SE
Britt, IA 50423
PH 641-843-3868 FX 641-843-3869



Blades

- Use only correctly designed and or sharpened saw blades manufactured in accordance with all applicable regulations..
- Use only blades that are rated at the specified 3600 RPM when machine is operate at 60Hz or 2825 when machine is operated on 50 Hz the RPM on the machine. No blade shall be used that is not rated for the rpm of the machine.

Lighting requirements

- The area around the machine must be well lit.

Use and Preventative Maintenance

Modifications:

- Any modifications to the machine including incorporation into an assembly, addition of integrated feeds or other changes are the responsibility of the end user and the end user must ensure ongoing compliance.

Additional Safety Actions to be Taken by End User

- Lock out Tag out procedures to be adopted during all maintenance.
- Lock out Tag out procedures to be observed when changing blade

Functional Testing

- Braking time test—tested monthly (20 second brake run down)
- Upper Guard locking—tested monthly, prove there is an inability to open upper guard without tools.
- Test lower guards for hang ups make sure upper plastic section drop down to cover blade
- Test lower ring guard (inner) test to make sure it moves freely, it is not bent, and does not hang up— must drop freely to lower portion of blade

General instructions for Safe Use:

- • Always observe the safety instructions and applicable regulations.
- • Ensure the material to be sawn is firmly secured in place.
- • Apply only a gentle pressure to the tool and do not exert side pressure on the saw blade.
- • Avoid overloading.
- • Install the appropriate saw blade. Do not use excessively worn blades. The maximum rotation speed of the tool must not exceed that of the saw blade.
- • Do not attempt to cut excessively small pieces.
- • Allow the blade to cut freely. Do not force.
- • Allow the motor to reach full speed before cutting.
- • Make sure all locking knobs and clamp handles are tight.
- • Never run the machine without the guards in place.
- • Never lift the machine by the table top.

Preventative Maintenance

Original Radial Arm Saws are designed to provide you with precision cutting with a minimal amount of maintenance. The frequency of the maintenance depends on the amount of use and the desired cutting quality.

Always disconnect and lockout power supply before performing maintenance.

Daily:

- Wipe down the machined tracks in the arm with a dry clean cloth. Removing this dust will keep it from building up on the tracks.
- Glance at the guards and make sure the upper guard is in good shape free from damage and the lower moveable portions have free movement and are not binding.

Preventative Maintenance — Continued

Weekly

- Perform daily PM tasks and then also:
- Make sure spring return pulls carriage back behind the fence from any position in the arm.
- Look at saw blade, make sure it is free of cracks and is sharp,
- Review all safety labeling and make sure they are intact and legible, if they are damaged order replacements from Original Saw Company.

Monthly / Bi-Monthly—Every 160 hours of use:









- Disconnect power from machine
- Remove saw blade, end cap, and stop bolt pull out carriage and gently rest the carriage assembly on the table top.
- Wipe down the machined tracks with denatured alcohol or paint thinner to remove any residual wood pitch buildup. **Note do not lubricate the tracks.**
- Wipe down the bearings with denatured alcohol or paint thinner to remove any residual wood pitch buildup. Check for free movement if there are any bad bearings have them replaced— they will cause wear and damage.
- Review all cords for cracks replace if damaged.
- Reassemble the carriage in the arm, reinstall stop bolt, end cap. Check for looseness in the carriage or left to right movement specifically near the fence area.
- The column should be wiped down with a clean dry rag, if there are any wood pitch please use denatured alcohol or pain thinner to remove then keep column dry.
- Vacuum the table and inside the frame to make sure sawdust is not building up in those areas.

Annually / Bi-Annually

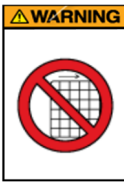
- Adjustment and alignment of saw is necessary only when cutting results in unacceptable accuracy but yearly take a square and double check alignment as shown starting on page 18.
- After many years of use your saw may need replacement parts. If any of the following wears out all others listed should be checked also.
- Arm Tracks: If the saw is used primarily for short cut-offs, the tracks may wear making it difficult to adjust the roller head bearing for full length arm travel. Arms can generally be re-machined—contact Original Saw for pricing and shipping instructions.
- Motor bearings: Check for free, smooth rotation. Do not attempt to lubricate. Replace every 5 years with factory original bearings. Or if unit is used more than 6-8 hours per day replace every 2 years.
- Elevating mechanism: Remove, clean and lubricate with type EP grease. Check for wear between nut and jack screw. Replace assembly if loose.

SYMBOLS / DECALS

The following symbols are used throughout this manual:
Denotes risk of personal injury, loss of life or damage to the tool in case of non-observance of the instructions in this manual.

1		Denotes risk of injury, loss of life, or damage to the tool in case of not observing the instructions in this manual.	6		Denotes hearing and eye protection required.
2		Denotes risk of electrical shock.	7		Denotes guards required to be in place.
3		Denotes risk of pinching hazard.	8		Denotes general safety hazard. See operators manual for more information pertaining to these areas.
4		Denotes hazard of rotating blade.	9		Denotes lift point.
5		Denotes hazard of entanglement.			



**Always replace damaged, missing, or illegible decals.
Contact Original Saw at 641.843.3868 for replacement
parts.**

Symbols / Decals

Arm:
General Caution

Guard:

- # 4 Hazard Rotating blade
- # 6 Hearing and eye protection
- # 7 Guards required to be in place
 - rotation direction
 - use blades rated at 3450 rpm



Arm: right side
Do not operate with
safety stop removed



Magnetic Starter:
Risk of electrical shock

Arm: left side
3 Denotes a pinch point on front
of bevel stop and roller head yoke
#5 Denotes hazard of entanglement

Frame:
4 Denotes lift point
Note there are 2 on front of frame
and 2 on the rear of the frame
#1 Denotes read manual before
using

Components and Controls

!!! CAUTION !!!

BOTH UPPER AND LOWER GUARDS MUST REMAIN IN PLACE FOR SAFE CUTTING OPERATION.

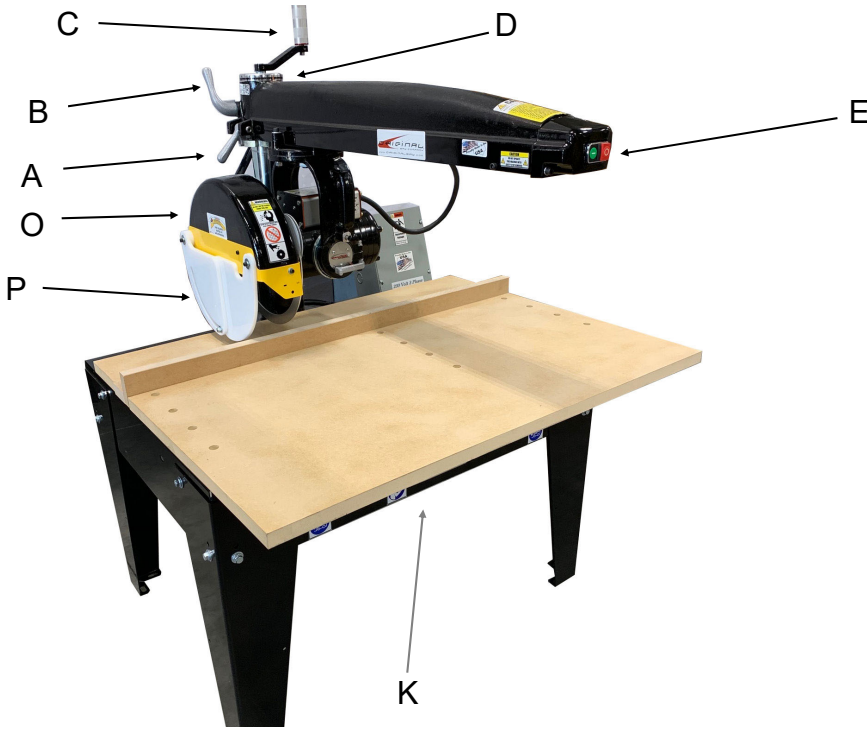

Control Locations

- A. Miter Latch Handle
- B. Arm Clamp Handle
- C. Elevating Control Handle
- D. Miter Scale
- E. On/Off Switch
- F. Adjustable Arm Stop
- G. Operating Handle
- H. Bevel Index Pin
- I. Bevel Scale
- J. Bevel Clamp Handle
- K. Serial Number Plate
- L. Carriage lock clamp
- M. Carriage return spring
- N. Magnetic starter assembly
(Usually mounted on wall)
- O. Blade guard (upper)
- P. Blade guard (lower) 2 pcs
- Q. Front table
- R. Fence board
- S. Spacer boards
- T. Elevating Base/Clamp Handle

*Medium arm models only

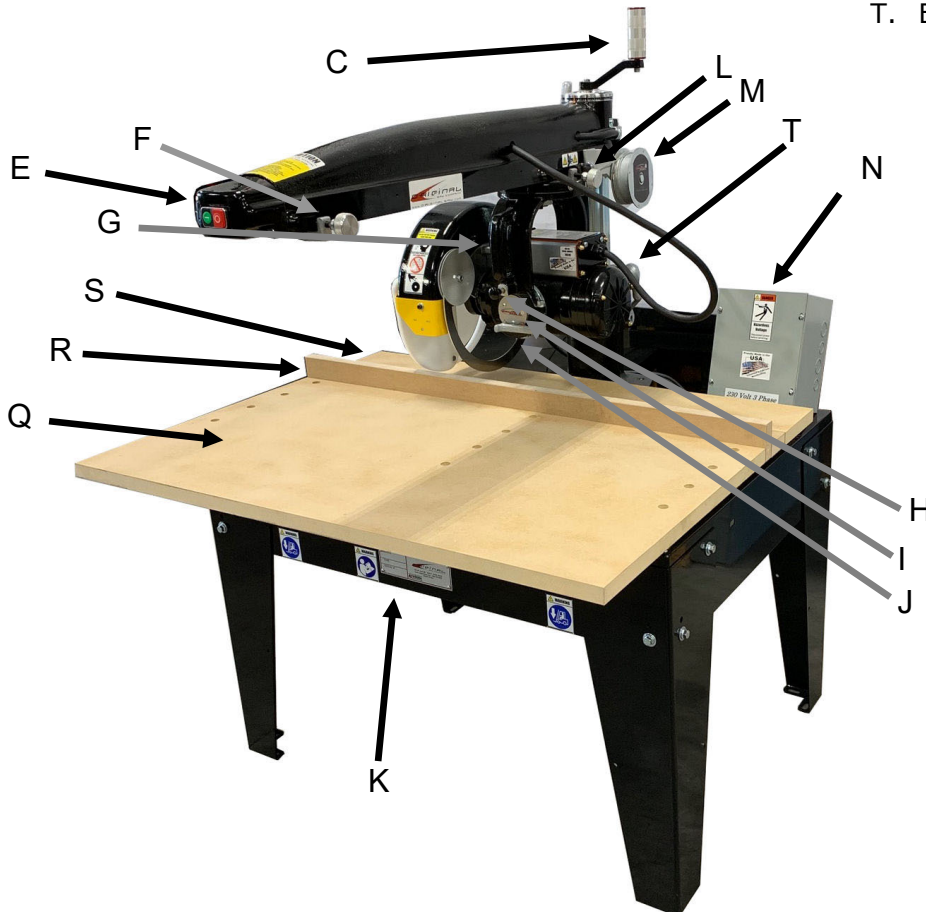

Heavy Duty Series

14" / 350mm 3531-01, 3536-01, 3531-03, 3536-03
16" / 400mm 3541, 3546

Standard equipment:

Machine, Complete upper and lower blade guard, carriage return attachment wrench kit, magnetic starter with overload/ low voltage protection, low voltage start/stop station, oversized MDF table top, heavy gage steel frame and leg stand.

		3531-01	3536-01	3531-03	3536-03	3541	3546
Motor Power (input)	W						
Motor Power (output)	W	2250	2250	3800	3800	3800	3800
Voltage	V	208/230	208/230	208/230/460/ 575	208/230/460/	208/230/460/ 575	208/230/460/ 575
Blade Diameter max	Inches/mm	14/350	14/350	14/350	14/350	16/400	16/400
Blade Bore	Inches/mm	1/25.4	1/25.4	1/25.4	1/25.4	1/25.4	1/25.4
Spindle Diameter	mm	25.4	25.4	25.4	25.4	25.4	25.4
No load speed 50Hz	rpm	2825	2825	2825	2825	2825	2825
No load speed 60Hz	rpm	3450	3450	3450	3450	3450	3450
Brake time	seconds	20	20	20	20	20	20
Depth of cut at 90°	Inches/mm	4.125"/ 100	4.125"/ 100	4.125"/ 100	4.125"/ 100	4.94"/ 125	4.94"/ 125
Depth of cut at 45°	Inches/mm	1.75"/ 44	1.75"/ 44	1.75"/ 44	1.75"/ 44	2"/ 50	2"/ 50
Max crosscut capacity at 0° in 25mm stock	Inches/mm	16"/ 400	24"/ 600	16"/ 400	24"/ 600	16"/ 400	24"/ 600
Max Miter cut capacity at 45° in 25mm stock	Inches/mm	10.875"/ 276	15.5"/ 393	10.875"/ 276	15.5"/ 393	10.875"/ 276	15.5"/ 393
Max crosscut width	Inches/mm	16"/ 400	24"/ 600	16"/ 400	24"/ 600	16"/ 400	24"/ 600
Max rip cut width	Inches/mm	n/a	n/a	n/a	n/a	n/a	n/a
overall dimensions (with legs)	Inches/mm	59" x 44" x 43" 1520x1120x1117	59" x 44" x 43" 1520x1190x1117	59" x 44" x 43" 1520x1120x1117	59" x 44" x 43" 1520x1190x1117	59" x 44" x 43" 1520x1120x1117	59" x 44" x 43" 1520x1190x1117
Dust extraction adapter (Optional)	Inches/mm	4"/ 100	4"/ 100	4"/ 100	4"/ 100	4"/ 100	4"/ 100
Weight	Lbs/kg	491lbs/223kg	520lbs/235kg	491lbs/223kg	520lbs/235kg	491lbs/223kg	520lbs/235kg

Electrical Connection—



Recommend Copper Wire Sizes (A.W.G.)

To obtain maximum efficiency from your saw motor, the feeder wire from the power source to the machine should comply with the table below.



Note: Always check arbor shaft rotation before installing blade, arbor nuts, or collars.

Wire sizes in this chart are the result of high start up amps.

Recommended Copper Wire Sizes

	1 Phase	3 Phase	3 Phase	3 Phase
<u>Up to 60' from power supply</u>	200-240 V	200-240 V	440-480 V	550-600 V
3 hp	#8 AWG	#8 AWG	#10 AWG	#10 AWG
5 hp	#6 AWG	#8 AWG	#10 AWG	#12 AWG
7.5 hp	N/A	#6 AWG	#8 AWG	#10 AWG

<u>60 - 100' From power supply</u>	200-240 V	200-240 V	440-480 V	550-600 V
3 hp	#6 AWG	#6 AWG	#8 AWG	#10 AWG
5 hp	#2 AWG	#6 AWG	#8 AWG	#8 AWG
7.5 hp	N/A	#4 AWG	#8 AWG	#6 AWG

<u>100 - 160' From power supply</u>	200-240 V	200-240 V	440-480 V	550-600 V
3 hp	#4 AWG	#4 AWG	#8 AWG	#8 AWG
5 hp	#0 AWG	#2 AWG	#8 AWG	#8 AWG
7.5 hp	N/A	#2 AWG	#4 AWG	#6 AWG

<u>Over 160' From power supply</u>	200-240 V	200-240 V	440-480 V	550-600 V
3 hp	#2 AWG	#2 AWG	#4 AWG	#4 AWG
5 hp	#00 AWG	#2 AWG	#2 AWG	#4 AWG
7.5 hp	N/A	#0 AWG	#2 AWG	#2 AWG



Note: Wire too large to insert into the provided magnetic starter will need to be terminated in a fused disconnect and #10 wire ran into the magnetic starter using less than 10 feet of cable.

Recommended Fuse / Breaker Size

(Located in the disconnect enclosure)

	1 Phase	3 Phase	3 Phase	3 Phase
	200-240 V	200-240 V	440-480 V	550-600 V
3 hp	60 AMP	20 AMP	20 AMP	20 AMP
5 hp	90 AMP	30 AMP	20 AMP	20 AMP
7.5 hp	N/A	45 AMP	20 AMP	20 AMP

SAW ASSEMBLY AND INSTALLATION

UNPACKING YOUR HEAVY DUTY SERIES SAW

Your Heavy Duty series saw system has been completely assembled, tested, and then partially disassembled. The shipment of your saw contains the following items:

- The Heavy Duty Series Saw, (4) frame legs, arbor wrenches, allen hex wrench kit, hardware to attach legs.



Your machine will be banded down to a shipping skid with the legs removed and packaged under the table top. To uncrate simply remove the corners and the framing from the skid and cut the bands that hold the saw to the skid. The unit can then be picked up with a forklift under the steel frame and then the legs can be installed using the 3/8 bolts, lock washers, and heavy hex nuts. Make sure to use the leg with the warning stickers on the left front. **Install bolts finger tight and place machine where it is to be set up then tighten legs this will allow machine to level itself to the floor. Note: if you are mounting our roller tables to the machine leave legs loose so assist in aligning the brackets properly then when all extension tables are installed tighten all bolts down.**

IMPORTANT

All cable lengths have been adjusted during manufacture to allow for proper movement of the arm and rollerhead. However, you should check the cables to ensure full range of movement. If adjustment is necessary, loosen the cable clamp (at right rear of arm) and adjust the cables so rollerhead is free to travel the total length of the arm. Check to ensure there is enough slack in the cables between the rear

FLOOR MOUNTING DIMENSIONS

Your saw may be mounted to the floor using 1/2" diameter hardware appropriate for the floor surface and located according to the diagram below. All dimensions are center-to-center.

Your saw may be mounted to the floor. Use the diagram at below to assist you in placing the saw and fastening it to the floor.

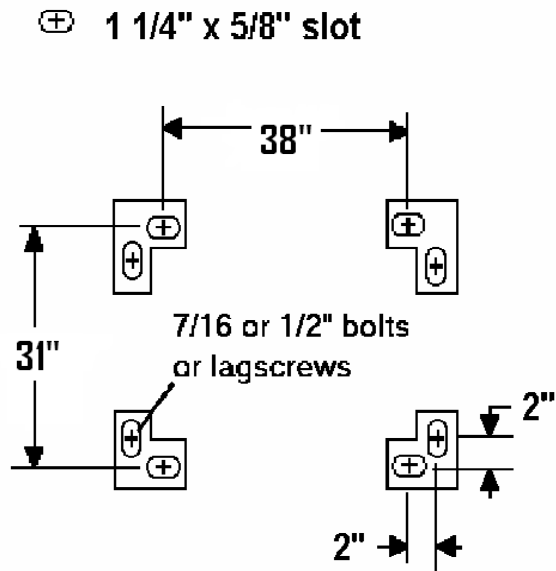

SAW ASSEMBLY AND INSTALLATION ... continued

Check Arbor Rotation (3 Phase Only)

Check arbor rotation with arbor nut and arbor collars removed. Open line disconnect to the saw to remove arbor nut and collars, close the line disconnect and start saw. The rotation of the arbor must be clockwise as indicated on the arrow on the nameplate. If the rotation is counterclockwise, the incoming wires are not properly connected to the switch box. To change the direction reverse any two of the wires leading to the switch box from the power supply.

Changing Voltage on dual voltage motors and Resetting Thermal Protection

Dual voltage motors can be operated on either of the two voltages indicated on the motor nameplate. The voltage setting from the factory can be found on the tag attached to the guard stud. Note Ty6 and newer models have DC power supplies that are voltage specific. To change the voltage:

1. Change the motor lead connections as shown on the diagram on the inside cover of the motor conduit box. This is also found on page 24-25 in this manual. Disconnect and lockout the power supply before attempting voltage change.
2. Change the DC power supply to the proper input voltage Note: power supplies are voltage specific and cannot be adjusted from 230 volt to 460 volt primary voltage. This is also found on pages 24-25 of the parts manual.
3. Replace or adjust the thermal overload protectors (D) using dial (A), see figures below) with those rated at the desired amperage range. If the overloads trip you will need to press reset button (C) to resume operation or set the thermal for auto-reset.
4. Contact your dealer or customer service via phone at 800-733-4063 or email at customerservice@originalsaw.com for correct information on thermal overload protectors.

Overload Protection

Your saw is equipped with automatic reset thermal overload protection. To restart after thermals have tripped, wait until the motor cools, then press the saw start button. If overloads continue to trip, the machine is being overloaded. Do not continue to operate under these conditions. This could indicate an electrical problem take the time to find the trouble and correct it—see the electrical trouble shooting section of this manual. The main power supply branch circuits should be fused by the use of fuses or breakers as follows using time delay fuses:

	1 Phase	3 Phase	3 Phase	3 Phase
Motor Horsepower	200-240 V	200-240 V	440-480 V	550-600 V
5	50	30	15	—
5	—	40	15	15

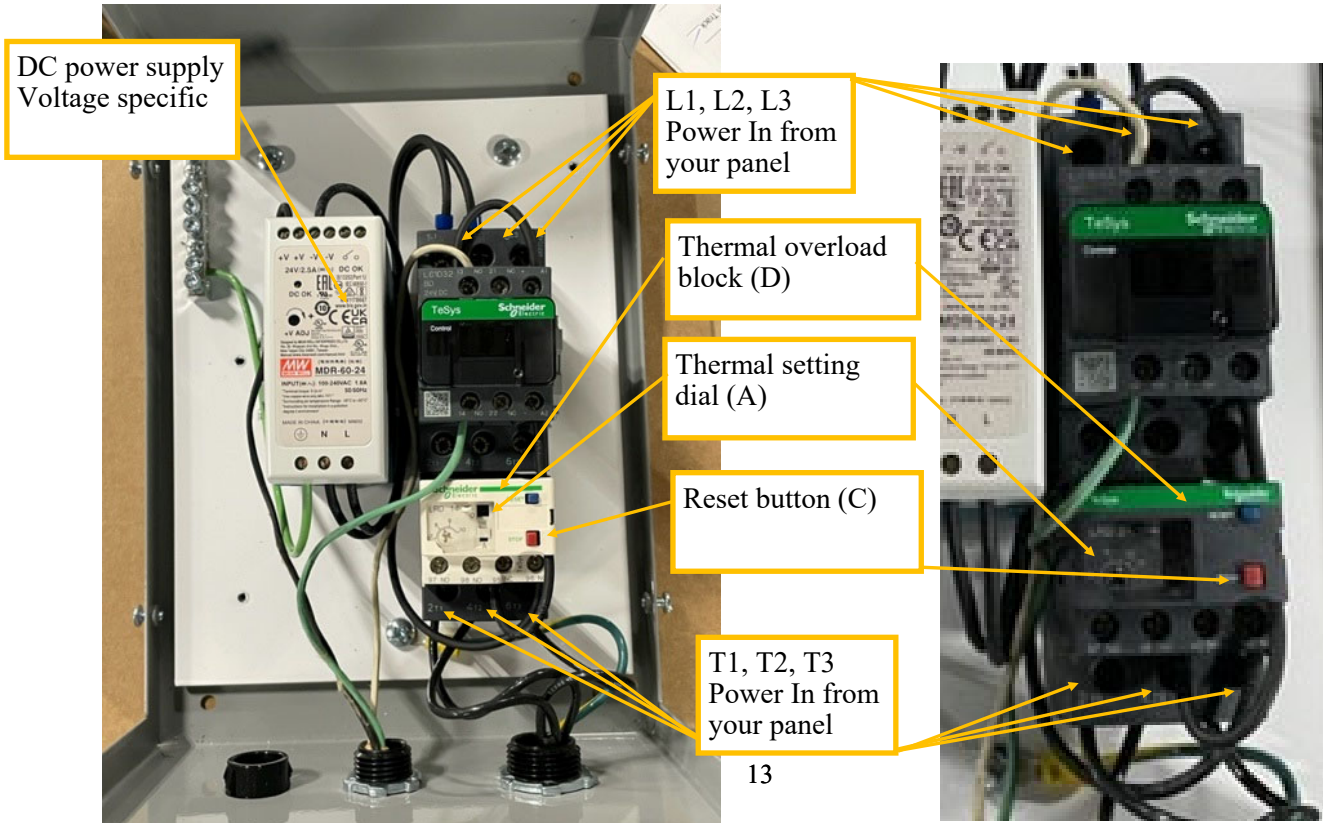

SAW ASSEMBLY AND INSTALLATION ... continued

General Safety Precautions

1. Be sure the blade rotates clockwise when facing the saw from the left side. Blade must rotate to the front of the saw.
2. Be sure all clamp handles are tight before turning on motor.
3. Keep the blade sharp and properly set.
4. Hold or clamp the material firmly against the guide strip when cutting.
5. Be sure the blade and arbor collars are clean and the recessed side of the collars are against blade.
6. Never oil or grease arm tracks or motor.
7. Do not start machine without proper tool guard.
8. Do not remove the anti-kickback device from the blade guard. Adjust it to just clear the work.
9. Keep motor air slots clean.
10. Return roller head to full rear after each operation.

General Cautions When Using the Lower Blade Guard:

1. Used properly the lower blade guard is designed to provide protection from contact with the side of the blade. It is not designed to prevent contact with the front or rear of the blade. When the lower guard contacts the fence or material being cut it will rise up and expose the blade. Be careful to keep your hands out of the line of the cut.
2. Lower blade guards may become caught in prior kerfs in the fence or table. Alleviate this by replacing the guide fence frequently. Always stop the saw before attempting to remove a guard that is stuck in a kerf.
3. Short cut-off pieces of wood may become caught between the lower guard and the blade. If this happens shut off the saw and wait until blade stops to remove the piece.
4. The lower blade guard's effectiveness is limited in bevel operations. It may have to be raised out of the way when setting the bevel angle. **Be sure the power is off/locked out and blade is completely stopped before making any adjustment.**
5. Catching the lower guard in saw kerfs when changing the saw setup can be avoided by elevating the saw until the bottom of the guard clears the fence.
6. Do not use the lower guard with any accessory other than the correct size blade.

Using the Adjustable Arm Stop

The arm stop should be used whenever roller head travel needs to be limited, such as when repetitive cross cuts are being made. Use of the arm stop will also prevent the blade from throwing small cut off pieces on the return stroke. **Do not adjust the arm stop unless the power is off and locked out and the blade stopped. The arm stop must be used on the right side of the arm.** Proper adjustment of the arm stop is completed as follows:

1. Pull the roller head forward far enough for the blade to sever the material and travel 1/4" past the material.
2. Lock the roller head to the arm with the riplock and place the arm stop so it is touching the roller head.
3. Loosen the riplock and return the roller head behind the fence.

Alternate Fence Board Positions

Your saw was assembled with the fence board in the most frequently used position on the work table (see figure 3). The fence board may be moved to alternate positions to accommodate varying uses. Moving the fence board behind the spacer board will allow for maximum cross cutting capabilities. Moving the fence board back to the rear board will provide for maximum ripping capability.

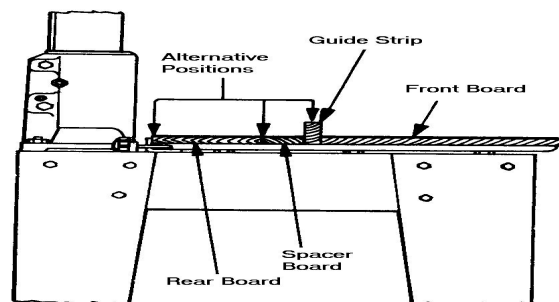

Figure 3

SAW ASSEMBLY AND INSTALLATION ... continued



Electrical Precautions

1. Be sure machine is properly grounded.
2. Do not attempt to operate saw on any voltage other than the one designated.
3. Use correct size time delay fuses to protect incoming current.
4. If it takes more than 3 seconds to reach maximum speed with a standard blade, turn the saw off. (See trouble shooting on page 26 of this manual).
5. Do not cause the motor to repeatedly approach a stall.
6. Do not attempt to start the saw for at least 15 minutes after thermal overload has tripped.
7. **Disconnect and lockout** the saw from the power source before opening a starter box, conduit box or whenever removing a guard.



Mounting the Blade (Caution! Disconnect power source before mounting blade)

1. Place the hex box wrench over the arbor nut and place the long allen wrench in the arbor shaft end hole. Place a wood striking block under the allen wrench to avoid marring the tabletop. Push down on the hex wrench to loosen nut (left hand threaded). (See figure 2)
2. Remove the nut and first arbor collar. Wipe the arbor collar faces and mounting area on the blade. Slide the blade on the shaft with the directional arrow away from the motor and pointing clockwise.
3. Place the arbor collar, recessed sides against the blade, arbor nut and tighten securely. (See figure 1)

FIGURE 1

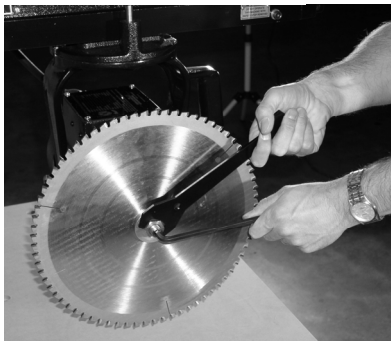
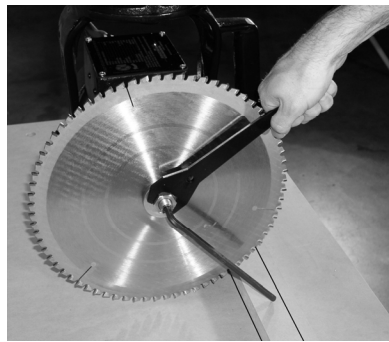

FIGURE 2



Guard Mounting (note guard is installed when machine is shipped) (Caution! Disconnect/lockout power source before mounting guard)

1. Remove the 1/4"x 20 Hex nut or wing nut from the right front lower guard mounting stud and remove the retainer washer.
2. Remove the right lower guard by sliding it backward and down.
3. Place the guard over the blade, tilting the guard to the right so the HDPE lower guard sections clears the end of the arbor.
4. Seat the die cast guard mount bracket in the groove on the front of the motor arbor end bell with the guard stud through the hole in the guard. Secure with wing nut.
5. Reconnect the lower right guard and replace the parts removed.
6. Move the carriage forward across the fence to verify proper operation then pull to the limit of its travel.

Caution: Your saw is now ready to use. Before using it, study the control locations (found on page 9), cautions and operating instructions contained in the following pages.

Adjusting the Saw Guard

The guard can be pivoted about the motor by loosening the wing nuts that connect the cast guard to the die cast guard mount bracket. **CAUTION—DO NOT ADJUST THE GUARD WHILE BLADE IS MOVING. KEEP ALL ADJUSTING MECHANISMS TIGHT.**

Operating Instructions

Moving the Arm Horizontally and Vertically

The elevating crank is used to raise or lower the arm to accommodate cutting operations (see below left). Do not adjust the height of the saw with the base / clamp handle tight (see page 9 for location) or while the motor is running. Change the position of the arm for miter cutting is done by pulling the arm clamp handle (A) forward and lifting the miter latch handle (B). Observing the miter scale, swing the arm either right or left to the desired angle. The arm can quickly be located at the 0° and 45° marks by using the indexing slots machined into the column ring. When you have located the saw at the required position engage both the miter latch and the arm clamp.



!!! CAUTION !!!

BOTH UPPER AND LOWER GUARDS MUST REMAIN IN PLACE FOR SAFE CUTTING OPERATION.



Rotating the Motor to Bevel Cutting Position

Raise the arm to allow the saw blade sufficient clearance above the table top. Release the bevel clamp handle (A) and pull the bevel index pin. (B) The motor can now be moved to a bevel position as indicated on the bevel scale. Un-Lock the motor by releasing the bevel index pin (possible only at 0°, 45° and 90°) and by locking the bevel clamp handle.



Cross Cutting



Lock the arm in the 0° position. Place the material securely against the guide strip- keep hands well away from the blade. Draw the saw blade across the material. After the cut has been completed return the blade behind the guide strip. Observe this order of operation for all cross cuts. Never push the saw blade into the material. Pull the blade slowly and firmly across the material from the rear of the arm using the operating handle. The saw blade should cut into the table about 1/16" when cutting through the material. Raise the anti-kickback to just clear the material being cut. Adjust for varying wood thickness or warped material.



Operating Instructions

Rip Cutting - (rip kit required and is Optional)



In Rip—Out Rip



When ripping the arm should be locked in a cross cut position. Pull the motor to the end of the arm. Release the yoke clamp handle by pulling forward and lift the rip index pin. Revolve motor 90° right or left for out-rip or in-rip position. Engage rip index pin and lock yoke clamp handle. Locate saw for desired width of rip and lock saw carriage by tightening riplock against side of arm. Rotate guard so the in-feed side almost touches the material. Lower anti-kickback assembly so the fingers are approximately 1/8" lower than the material. Place material against the guide strip and feed evenly into the saw blade. Use push board on narrow work. Never place hands between blade and guide fence. Do not force material and **DO NOT** feed from the kickback side of the guard. Serious injury could result. **Note Red arrows indicate direction of material movement.** Continued on next page.

!!! DANGER !!!
NEVER FEED MATERIAL FROM THE KICKBACK (Front) SIDE OF THE GUARD. SERIOUS INJURY COULD RESULT.

Operating Instructions

Rip Cutting - (rip kit required and is Optional)

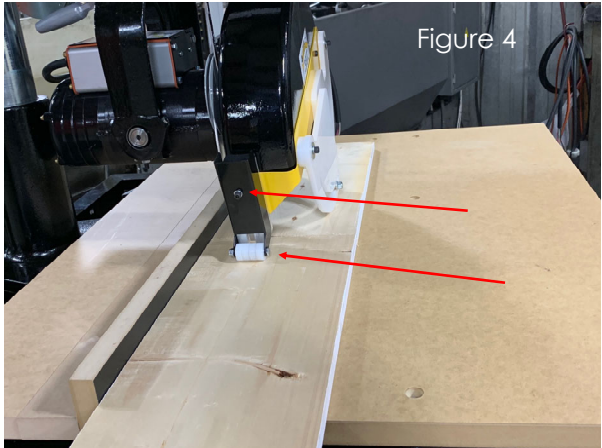
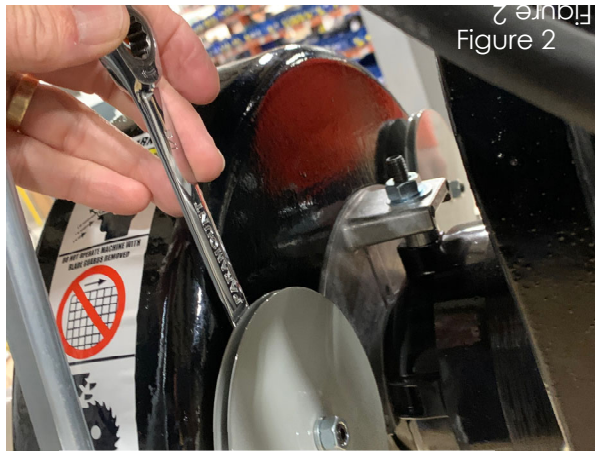
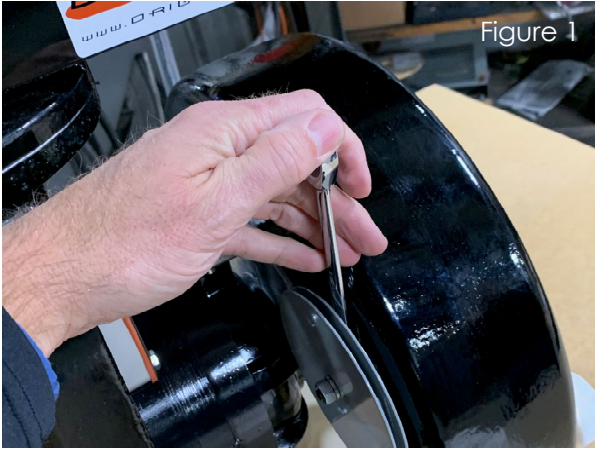

In Rip—Out Rip

To set up guard for ripping start by swiveling the carriage into the in rip or out rip position. Then using a wrench loosed the studs that run through the inner guard ring retainers on both the front and back retainers as in figure #1 and Figure #2. The rotate the guard back or to the rear to bring the rear bottom edge of the guard closer to the material being cut Figure 3. Using the thumb screw adjust down the material hold down roller to contact the surface of the material being ripped (Red arrows in Figure 4). Then adjust down the kickback attachment on the front of the guard so the steel fingers contacts the materiel slightly (red arrow in Figure 3). This will keep the material from kicking back out of the machine.

Bevel Cutting



Lock the arm in the cross cutting position. Raise the motor by rotating the elevation crank. Release the bevel clamp and the bevel index pin and tilt the motor in the yoke. The bevel angle is shown on the bevel scale. Release the bevel index pin and lock the bevel clamp. Lower the arm into cutting position. Adjust the arm stop to assure clearance between blade and base. Pull the saw through as you would for cross cutting.

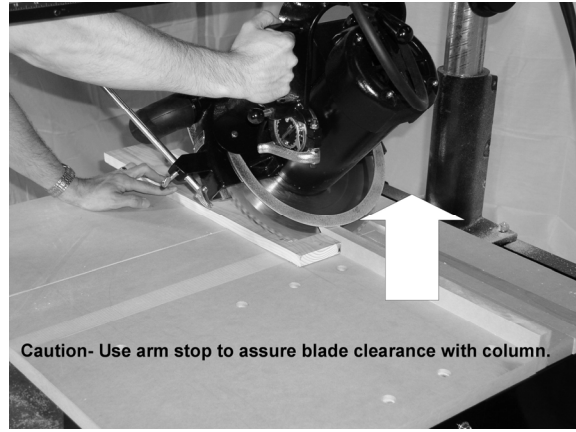

Caution- Use arm stop to assure blade clearance with column.



Compound Miter Cutting

The compound miter is merely a combination of the bevel cut and the miter cut. Set up the machine for bevel cutting. Release the arm clamp handle and the miter latch handle. Move the arm into the required position and lock the miter latch and arm clamp. Adjust arm stop to assure clearance between blade and base. Pull the blade through as you would for cross cutting.



Adjusting the tension on the auto carriage return spring

Upon original setup of your Original saw you may want to adjust the tension on the auto carriage return spring for personal preference. To tighten or add tension to the carriage, carefully turn the return spring counter clockwise or to the left until you have enough slack in the cable to add a winding. To loosen, carefully turn the return spring counter clockwise or to the left until you have enough slack in the cable to remove a winding.

WARNING: IF YOU UNIT HAS BEEN WORKING CORRECTLY AND IS IN NEED OF TIGHTENING BECAUSE THE CARRAIGE IS NOT RETURNING TO THE HOME POSITION BEHIND THE FENCE BY ITSLEF THE ARM TRACKS AND THE BEARINGS MAY NEED TO BE CLEANED.

WARNING!! DO NOT OVERTIGHTEN THIS WILL RESULT IN DAMAGE TO THE SPRING AND THE CABLE ASSEMBY



Maintenance Adjustments and Alignments

Caution! Disconnect and lockout power supply before making any adjustments or alignments.

Your saw has been completely assembled, aligned and tested at the factory...then partially disassembled for shipment. Handling during shipment may cause some misalignment and the following information will enable you to correct any cutting inaccuracy you discover. These adjustments may also be necessary after a period of use. (See preventive maintenance on page 7 of this manual.)

Important ...Since one adjustment may affect another it is important to run through the adjustments in the sequence as follows.

Adjustment of Base to Column Fit

If excessive side motion exists at the end of the arm while the arm clamp is engaged, adjustment to the base or bronze gib (C) is generally necessary. To adjust:

1. Loosen all pinch bolts (A) and set screws (B). Pull the arm clamp handle forward.
2. With the motor and yoke in the rearmost position the elevation effort should be easy. Tighten the bottom pinch bolt until there is an increase in the elevation effort. Once elevation becomes snug back off the bolt 1/4-1/2 turn. Repeat this for all the pinch bolts.
3. Tighten the gib set screws (B) hard, then back them off. Run them back up against the gib lightly, then snug up the locknut.
4. If the saw is equipped with a column clamp handle the adjustment should be made so that the clamp firmly secures the post when pushed back and released when the handle is pulled forward.

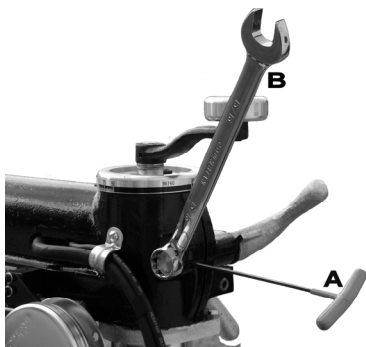
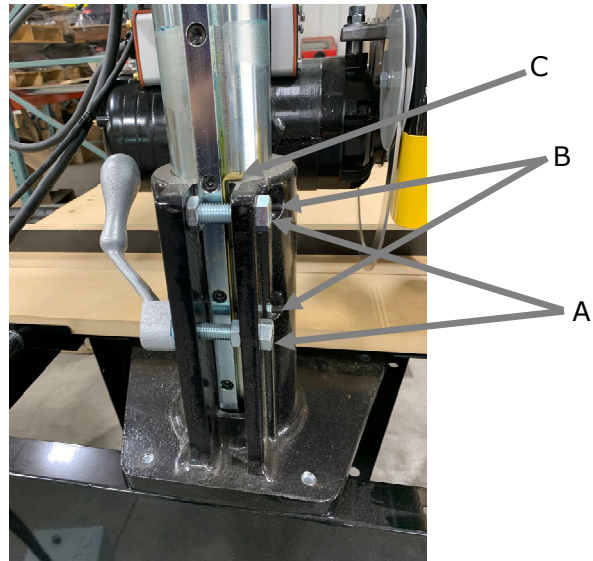

Adjustment of the Arm Clamp

The arm clamp holds the arm tightly on the column in the desired position for cutting. The arm clamp handle should be upright when tightened. If it goes beyond center adjust as follows:

1. Place motor carriage in the rearmost position.
2. Loosen the arm clamp set screw (A).
3. Move arm clamp handle to upright position and tighten the arm clamp handle bolt (B). Note this is a left hand threaded bolt.
4. Tighten the screw.

Adjustment of the Roller head to Arm

Accurate work cannot be done if the roller bearings in the motor carriage are not in proper adjustment. When play develops between the roller head and the arm the following adjustment is required:

1. Bring the roller head to the front of the arm and lock in place using the adjustable stop. Move saw to in-rip position.
2. Loosen the sockethead screws holding the arm end cap and rotate the end cap upward to expose bearings.
3. Clean the tracks thoroughly. Wipe them clean with a solvent, **do not** use kerosene. Use extreme caution as most solvents are toxic and/or flammable. **Do not** grease or oil the tracks.
4. Loosen the locking set screws (A) two full turns to release the eccentric shafts. (Both are located on the right hand side.)

Continued on the next page

Adjustment of the Roller head to Arm (cont'd)

5. Insert socket wrench into bottom of bearing shaft (B) and turn until the bearing touches the arm track on both top and bottom tracks. Repeat for both shafts. Bearings should be tightened only so that they roll and do not slide.
6. Replace the end cap and return saw to normal position.



Note-Too much pressure on the roller bearings will cause excessive and unnecessary wear in the parts and make the carriage work harder. Seven to ten pounds average pull on the carriage is a desirable preload.

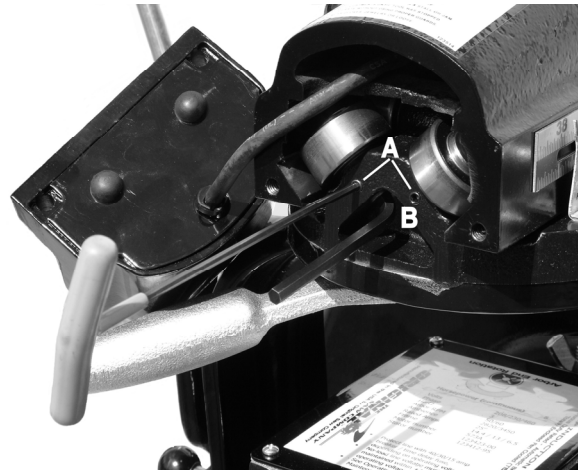

Adjustment of Table Top Parallel to Arm

The arm tracks must be parallel to the tabletop at all points. This assures uniform depth of cut, especially when dado cutting. Remove the blade and insert an arbor wrench or allen wrench between the saw arbor collars. Lower the wrench until it touches the tabletop. Lower the carriage until it touches the tabletop. If the top is not level:

1. Locate the highest point by swinging the arm from side to side and moving the carriage back and forth on the arm.
2. Loosen the lock nuts beneath the table frame.
3. Raise the jack screws so as to bring the low parts of the tabletop level with the high spots.
4. Tighten the lock nuts beneath the table frame.



How to check the fence board For Accuracy

For accurate work the fence board must be straight. If the machine has been exposed to the weather or used for a period of time the wood parts may become warped or worn so that the fence board is no longer straight. It should be made straight by planing and sanding or replacing. Check it with a straight edge or square before proceeding and make any adjustments necessary.

Caution! Disconnect and lockout power supply before making any adjustments or alignments.

To Square Saw Blade with the Table Top

Pull the saw to middle of table and lock into place. Make sure the tabletop is level and place a steel square against the side of the blade; the square should be against the gullets and not the teeth of the blade. If the blade is not square to the tabletop:

1. Remove two screws holding the bevel pointer.
2. Loosen the two socket head cap screws (A) located on the outside of the dial plate.
3. Release the bevel clamp handle (B).
4. Rotate the motor so the saw blade is flat against the square. Tighten the two locking socket head cap screws.
5. Replace the bevel pointer.
6. Engage the bevel clamp and recheck for square.
7. Adjust the bevel pointer washer/logo plate to line up with zero on the bevel scale.

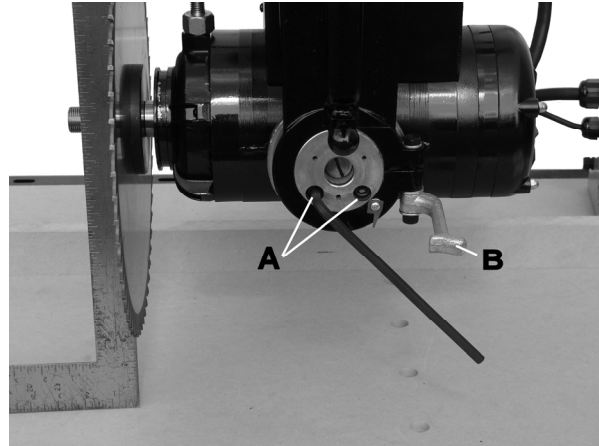

Adjustment of Bevel Clamp Handle

The bevel clamp holds the motor tightly at any angle by clamping the yoke around the dial plate. If adjustment becomes necessary do the following:

1. Release the bevel clamp handle by pulling it away from the dial plate as shown.
2. Use an allen wrench to hold the cap screw stationary and adjust the jam nut as necessary.
3. Engage the bevel clamp.

Adjusting Crosscut Travel Parallel to Arm Tracks

The leading and trailing teeth of the saw blade should travel in the same plane parallel to the arm tracks. When the saw blade is not parallel to the arm the result will be what is called "heel" - the back of the blade will not follow in the kerf of the front of the blade. Signs of a blade heeling are indicated when the rear teeth of the blade mark the material with an offset in the cut. This may be checked by cutting a piece of material at least 1" x 4". Place the material against the guide fence and crosscut a narrow strip; do not pull the saw blade entirely through the material but just allow the front teeth to clear the material. Stop the cut with the rear teeth remaining in the cut. Stop the saw and pull the material away from the blade prior to returning the blade behind the guide fence. Adjustment is necessary if rear teeth marks are prominent on either side of the cut (the rear teeth will arc toward the guide fence). This can also be checked by placing a square across the blade as shown; be sure to avoid placing any part of the square on the teeth. The square should be in contact with the blade in both the front and rear. To correct this situation:

A. If marks are made on the right hand side of material:

1. Release the bevel clamp handle.
2. Loosen the right and left lock nuts on the rear yoke trunion bushing.
3. Unscrew the left set screw about 1/6th turn and screw in the right screw the same amount.
4. Tighten the lock nuts, engage the bevel clamp handle and recheck.

B. If marks are made on the left hand side of material:

1. Release the bevel clamp handle.
2. Loosen the right and left lock nuts on the rear yoke trunion bushing.
3. Unscrew the right set screw about 1/6th turn and screw in the left screw the same amount.
4. Tighten the lock nuts, engage the bevel clamp handle and recheck.

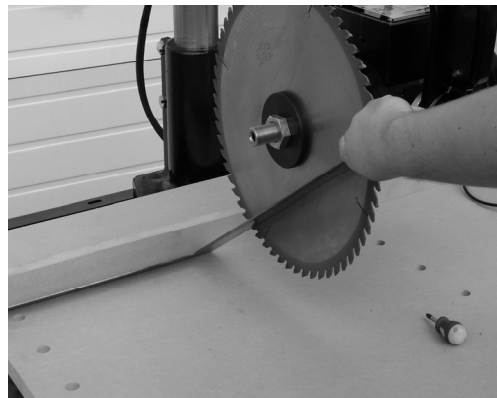

Continued next page...

Adjusting Crosscut Travel Parallel to Arm Tracks (continued)

After making the left and right adjustments, tilt the motor to a 45° bevel cutting position and make cuts in a 2" x 4" piece of material. If tooth marks appear the motor is too high or low in the rear yoke:

A. If marks are made on the bottom side of material:

1. Release the bevel clamp handle.
2. Loosen the right and bottom lock nuts on the rear yoke trunion bushing.
3. Unscrew the left set screw about 1/6th turn and screw in the same amount the set screw located on the bottom of the yoke trunion.
4. Tighten the lock nuts, engage the bevel clamp handle and recheck.

B. If marks are made on the upper side of material:

1. Release the bevel clamp handle.
2. Loosen the right and left lock nuts on the rear yoke trunion bushing.
3. Unscrew the bottom set screw about 1/6th turn and screw in the left screw the same amount.
4. Tighten the lock nuts, engage the bevel clamp handle and recheck.

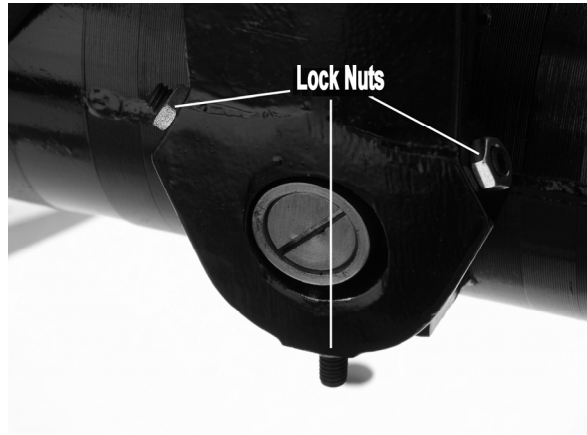

If after making these adjustments the blade continues to heel, particularly if the blade heels on both sides of the material, the blade may require tensioning. If the blade must be re-tensioned contact your local distributor.

Square the Saw Travel with the fence board

Place a square against the fence board and along the path of the blade. Pull the saw carriage as though making a crosscut and observe the position of the blade in relationship to the square. If the crosscut line is not square adjust as follows:

1. Loosen the arm clamp handle (A).
2. Loosen set screws (B).
3. Move saw carriage along square to determine necessary adjustment.
4. If the blade moves toward the square as it comes forward; disengage the miter latch (C), unscrew the rear adjusting screw (D) 1/8 of a turn and screw in the front adjusting screw (D) 1/8 turn. If blade moves away from square go to instruction #6.
5. Engage miter latch and recheck. If saw travel is now square, tighten set screws and engage arm clamp.
6. If the blade moves away from the square as it comes forward: disengage miter latch (C), loosen the front adjusting screw (D) and tighten the rear adjusting screw (D). Engage the miter latch, recheck and repeat as needed.
7. After saw travel has been properly aligned tighten the set screws (B) to lock adjusting screws in place.

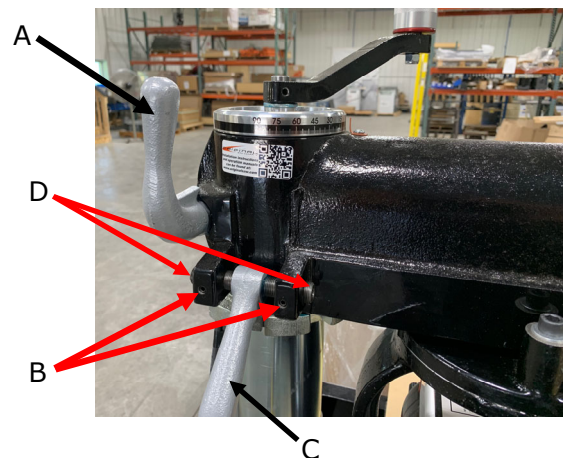
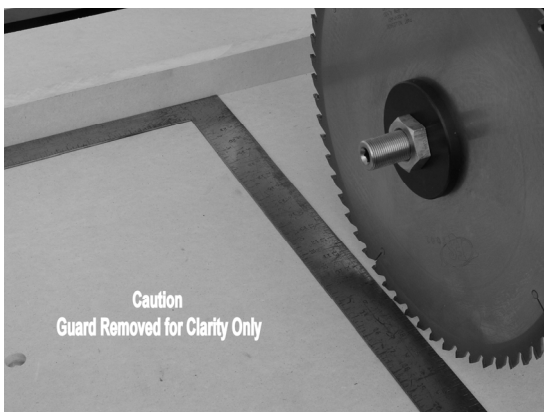

Caution! Disconnect and lockout power supply before making any adjustments or alignments.

Changing the Motor Voltage

WARNING—DISCONNECT AND LOCKOUT POWER BEFORE SERVICING

If your machine requires a different voltage, follow the instructions below. The motor will need to be rewired according to the diagrams below. The DC power supply will need to be replaced for the proper input voltage and the thermal overloads must be reset or replaced with the proper pieces to maintain thermal motor protection.

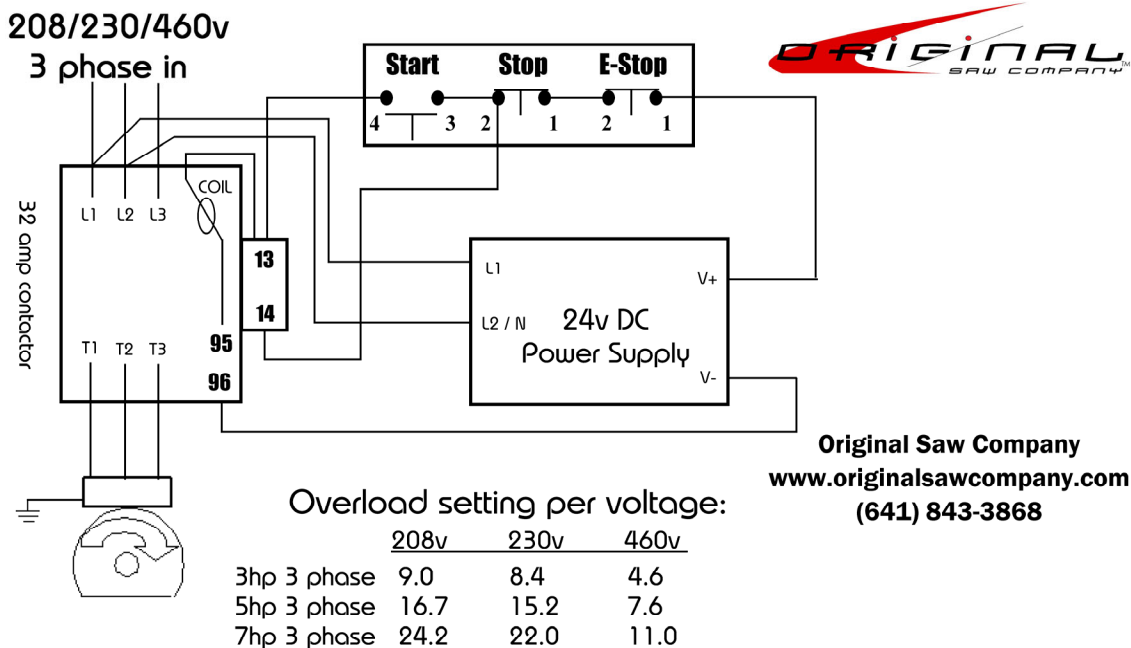

Motor lead wiring diagram

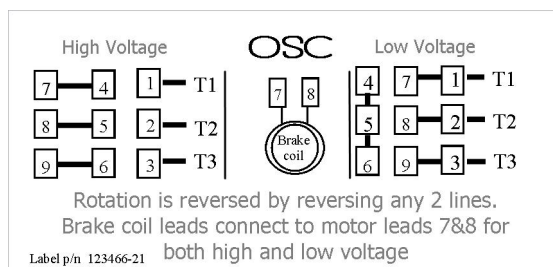

instructions for Changing the Motor Voltage

- 1) **Disconnect and lockout power**– Electrical shock could occur if this is not done.
- 2) Reconnect motor and transformer leads as shown in the chart above to match your required voltage. Paying careful attention to make sure the brake coil lines are still attached to motor leads #7 and #8.
- 3) Reset the dial for the proper amperage setting shown in the chart above. If your overload block does not have the proper settings, the block will have to be replaced with one appropriate for your voltage.
- 4) Recheck all connections and replace lids on the motor box and magnetic starter enclosure before restoring power.

1 phase wiring diagram

WARNING—DISCONNECT AND LOCKOUT POWER BEFORE SERVICING

If your machine requires a different voltage, follow the instructions below. The motor will need to be rewired according to the diagrams below. The thermal overloads must be reset or replaced with the proper pieces to maintain thermal motor protection.

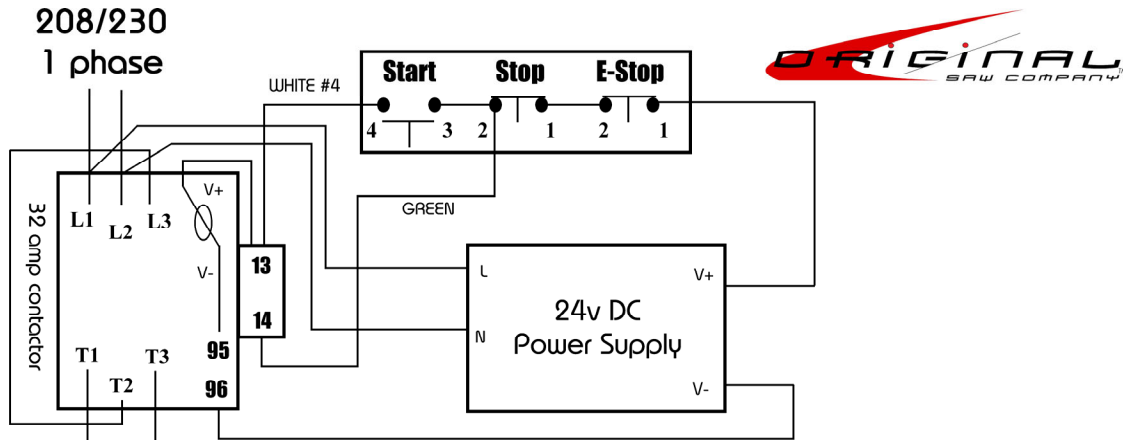

Overload setting per voltage:

	208v	230v
3hp 1 phase	18.7	17
5hp 1 phase	30.8	28

Original Saw Company
www.originalsawcompany.com
 (641) 843-3868

Motor lead wiring diagram

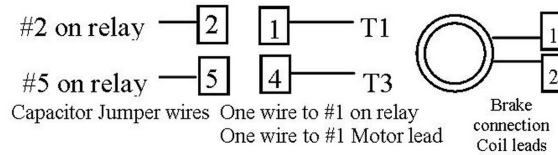

Alignment Guide for Accurate Cutting

The following guide is provided for your convenience. A saw that is not properly adjusted will not yield the desired accuracy and quality of cut. It should be noted any adjustment made will effect another, therefore it is best to perform all of the adjustments when correcting any one problem.

PROBLEM	POSSIBLE CAUSE	SOLUTION
Saw will not make a square cross cut or a good 45° miter cut	<ul style="list-style-type: none"> - Arm is not perpendicular to fence board - Arm has excessive play at end - Column is loose in base - Too much play between arm and column - Rollerhead loose in arm (left to right play) - Yoke loose when clamped to rollerhead - Sawdust between lumber and guide fence - Table not parallel with arm - fence board not straight/rear edge of fixed board not straight 	<ul style="list-style-type: none"> - Adjust cross cut travel with fence board (p. 20) - Tighten adjusting screws - Make proper adjustment (p. 18) - Make proper adjustment (p. 18) - Adjust rollerhead (p. 19) - Adjust yoke clamp handle (p. 19) - Clean tabletop - Make proper adjustment (p. 19) - Replace fence/sand or replace (p. 19)
Lumber has a tendency to walk away from fence when ripping or ploughing	<ul style="list-style-type: none"> - Saw blade is not parallel with fence - Arm not perpendicular to guide fence - Dull blade or cutters 	<ul style="list-style-type: none"> - Make heel adjustment (p. 13) - Adjust crosscut travel with guide fence (p. 14) - Sharpen or replace blade
Saw stalls when ripping or ploughing	<ul style="list-style-type: none"> - Fence not straight - Feed rate too fast - Wrong blade - Column too loose in base - Too much play between arm and column - Rollerhead loose in arm - Yoke loose when clamped to rollerhead - Sawdust between lumber and fence 	<ul style="list-style-type: none"> - Replace fence - Slow feed rate - Use correct blade - Make proper adjustment (p. 11) - Make proper adjustment (p. 11) - Make proper adjustment (p. 11) - Make proper adjustment (p. 12) - Clean tabletop
Saw blade scores lumber, finish cut is not smooth	<ul style="list-style-type: none"> - Saw blade is heeling - Column too loose in base - Too much play between arm and column - Rollerhead loose in arm - Yoke too loose when clamped to rollerhead - Bent or dull blade - Not feeding saw properly - Using improper blade 	<ul style="list-style-type: none"> - Make heel adjustment (p. 20) - Make proper adjustment (p. 18) - Make proper adjustment (p. 18) - Make proper adjustment (p. 19) - Make proper adjustment p. 19) - Replace blade - Draw blade across lumber with slow steady pull - Change blade.

PROBLEM	POSSIBLE CAUSE	SOLUTION
Saw blade or dado blades tend to push lumber to one side when cross cutting	<ul style="list-style-type: none"> - Saw blade is heeling - Column too loose in base - Too much play between arm and column - Rollerhead too loose in arm - Yoke too loose when clamped to rollerhead - Fence not straight - Dull blade or cutters 	<ul style="list-style-type: none"> - Make heel adjustment (p. 20) - Make proper adjustment (p. 18) - Make proper adjustment (p.18) - Make proper adjustment (p. 19) - Make proper adjustment (p. 19) - Replace fence - Replace or sharpen
Cut depth varies from one end of stock to the other	<ul style="list-style-type: none"> - Tabletop not parallel with arm - Column too loose in base - Too much play between arm and column 	<ul style="list-style-type: none"> - Adjust tabletop to arm (p. 19) - Make proper adjustment (p. 18) - Make proper adjustment (p. 18)
45° bevel cut not accurate	<ul style="list-style-type: none"> - Saw blade not perpendicular to tabletop - Column too loose in base - Too much play between arm and column - Rollerhead too loose in arm - Yoke too loose when clamped to rollerhead - Bevel clamp handle loose - Tabletop not parallel to arm 	<ul style="list-style-type: none"> - Make proper adjustment (p. 20) - Make proper adjustment (p. 18) - Make proper adjustment (p. 18) - Make proper adjustment (p. 19) - Make proper adjustment (p. 19) - Make proper adjustment (p. 20) - Make proper adjustment (p. 19)
Saw tends to advance over lumber too fast	<ul style="list-style-type: none"> - Rollerhead bearings out of adjustment - Dull blade - Not feeding saw properly 	<ul style="list-style-type: none"> - Adjust bearings (p. 19) - Replace or sharpen blade - Draw blade across lumber with a slow steady pull
Saw does not move smoothly in arm tracks	<ul style="list-style-type: none"> - Dirty tracks - Bad bearing 	<ul style="list-style-type: none"> - Clean tracks - Replace bearing
Miter scale not accurate at various miter angles	<ul style="list-style-type: none"> - Scale pointer not properly adjusted 	<ul style="list-style-type: none"> - Adjust scale pointer
Elevating handle slips when elevating or lowering the saw	<ul style="list-style-type: none"> - Base not adjusted properly 	<ul style="list-style-type: none"> - Adjust base to column (p. 18)
Clamping force not sufficient at miter angles other than 45°	<ul style="list-style-type: none"> - Arm clamp out of adjustment 	<ul style="list-style-type: none"> - Adjust arm clamp (p. 18)
Clamping force not sufficient at bevel angles other than 45°	<ul style="list-style-type: none"> - Bevel clamp handle too loose 	<ul style="list-style-type: none"> - Adjust bevel clamp (p. 20)

ELECTRICAL TROUBLE-SHOOTING GUIDE

CAUTION—HIGH VOLTAGES ARE DANGEROUS—BE SURE POWER IS OFF AND LOCKED OUT WHEN INSPECTING OR REPAIRING MOTOR OR CONTROLS

TROUBLE	POSSIBLE CAUSE	SUGGESTED REMEDY
Saw motor will neither start nor hum	Power line not connected to cable.	Correct power wiring. See wiring diagram inside magnetic starter box.
	Thermal overload relays may have tripped.	Allow time for overload relays to cool.
	Faulty (brown) line fuse, line circuit breaker tripped.	Check for presence of proper voltage at motor.
	Defective control transformer.	Check circuit with continuity meter. Ensure power is off.
	Start and stop switches at end of arm may be defective.	
	Faulty starter.	
Saw motor hums but will not start (Shut off power immediately)	Open circuit in a thermal relay heater.	Remove heaters. If defective, heater may be completely burned up. Install new heater if required.
	Open circuit in motor cable or cable lugs.	Use a continuity meter and check each wire between control unit and motor. Check lug connections.
	Wiring error.	Check connections in starter box and conduit box, refer to motor and starter connection diagrams.
	Mechanical binding—shaft should turn freely by hand.	Tap end of shaft with mallet to seat bearings in end bells. Check bearings and bell etc. Replace as needed.
	Low voltage—voltage should be measured at the motor while it is starting and blade attached. Voltage should not drop lower than 185 volts for 208, 220 and 230 volt systems.	Check for loose or high resistance connections— make sure lines are of ample capacity and other equipment is not pulling down the voltage.
	Burned out stator	If motor smells or has been smoking each phase winding should be checked with a test lamp or continuity meter.
	Bad capacitor (single phase only).	Turn off power, remove motor nameplate. Discharge capacitor by short circuiting terminals; remove motor from circuit. Test with ohm meter. Needle should jump when leads are touched to capacitor terminals and fall back to a high resistance as capacitor charges.
	Bad starting relay (single phase only).	If contacts are excessively burned, pitted or welded together the relay must be replaced. Check for open relay coil using continuity meter.
Motor trips overload relay or blows line fuse.	Wrong heater or fuse.	Replace with proper heater, fuse or circuit breaker.
	Excessive currents.	Check for grounds or shorts.
	Low voltage.	Check voltage while starting as outlined above.
	Loose or faulty connection.	Locate and repair.

IMPORTANT

IMPORTANT

IMPORTANT

To assure product reliability, repairs, maintenance and adjustments should be performed by Authorized Service Centers, always using genuine replacement parts.

For parts or service please contact Original Saw for the dealer nearest you.



465 Third Ave SE
P.O. Box 331
Britt, IA 50423
PH 800/733-4063 641-843-3868
FX 641 / 843-3869
E-mail customerservice@originalsaw.com
www.originalsaw.com

Printed in the USA © The Original Saw Company 09/2022 HD Series Type 6
(Updated 12/9/22)