



Original Saw Company
465 Third Ave SE
Britt, IA 50423 USA

PH 641-843-3868
800-733-4063

customerservice@originalsaw.com
www.originalsaw.com

Getting Started

Unpacking, general machine precautions, wiring,
installation

Operations & Maintenance Manual

WARNING: FOR YOUR SAFETY READ AND UNDERSTAND THIS MANUAL PRIOR TO USING THE SAW. REVIEW ALL SAFETY RULES AND OPERATING INSTRUCTIONS FREQUENTLY.

This manual is provided for your convenience in the use and care of your saw. These instructions include operation, precautions, preventative maintenance and other pertinent data to assist you in assuring long life and dependable service from your saw.



RADIAL ARM SAW TYPE 10 - cross cut only

20" models	3553, 3558
22.5" models	3554, 3559

For Serial number 20190603790 forward
(May 2020)

TABLE OF CONTENTS

SECTION	PAGE
Service Record	2
Warranty Information	3
Power Tool Safety	4-5
Preventative Maintenance	5-6
Symbols / Decals	7
Decal Locations	8
Saw Components and Controls	9
Product Specifications	10-11
ANSI Conformance	12
Saw Assembly and Installation	13-17
Electrical Connections	14-16,29-30
Arbor Rotation	14
Changing Motor Voltage	14, 29
Operating Instructions	18-22
Blade Mounting	17
Alignment and Adjustments	23-28
Parts Diagram and Listings	25-34
Troubleshooting	31-33

Industrial Use Warranty Information

Your new Original Radial Arm Saw is precision manufactured under strict quality standards. In the unlikely event there is trouble with your machine, the Original Saw Company warrants the machine for the period of one year from the date of purchase. The warranty covers defects in materials and workmanship. We will cover the cost of the defective part and ground shipping. If a replacement part is sent under warranty the defective part must be returned to Original Saw Company or you will be charged for the replacement. The part must also be accompanied by a return goods authorization number. This number can be obtained by calling customer service at 1-800-733-4063. When the part is returned it may be repaired or replaced at our discretion. The part must be shipped prepaid to: The Original Saw Company, Attn. Warranty Replacement Counter, 465 Third Avenue SE, Britt, Iowa 50423.



POWER TOOL SAFETY

GENERAL RULES FOR SAFE OPERATION OF POWER TOOLS

1. **KNOW YOUR POWER TOOL.** Read the owner's manual carefully. Learn the applications and limitations as well as the specific potential hazards of the tool.
2. **GROUND ALL TOOLS.**
3. **KEEP GUARDS IN PLACE.** Keep guards in working order.
4. **KEEP WORK AREA CLEAN.** Cluttered areas and benches invite accidents.
5. **AVOID DANGEROUS ENVIRONMENTS.** Don't use power tools in damp or wet locations. Keep work area well lit.
6. **KEEP CHILDREN AWAY.** All visitors should keep a safe distance from the work area.
7. **DON'T FORCE TOOL.** The tool will do a better job if used at its designed rate.
8. **WEAR PROPER APPAREL.** Loose clothing, gloves or jewelry may get caught in moving parts. Rubber footwear is recommended when working outdoors.
9. **USE PROTECTIVE GLASSES.** If operation is dusty also wear a dust mask.
10. **DON'T OVER REACH.** Keep proper balance and footing at all times.
11. **MAINTAIN TOOLS WITH CARE.** Tools kept sharp and clean provide the best and safest performance. Follow instructions for lubricating and changing accessories.
12. **DISCONNECT TOOLS FROM POWER SOURCE.** When not in use, before servicing, when changing accessories, blades, or cutters, the tool should be disconnected and locked out.
13. **REMOVE ADJUSTING KEYS AND WRENCHES.** Make it a habit to ensure keys and adjusting wrenches are removed prior to starting tool.
14. **USE RECOMMENDED ACCESSORIES.** Consult your distributor or Original Saw Company for recommended accessories. Using improper accessories may cause hazards.
15. **SECURE YOUR WORK.** Use clamps or a vise to hold work when practical.
16. **NEVER LEAVE TOOL RUNNING WHILE UNATTENDED.**
17. **ONE OPERATOR ONLY.** The person who operates the saw should also position the work.
18. **DO NOT REMOVE SMALL SCRAPS FROM THE TABLE WITH YOUR FINGERS.**



CAUTION

ALL GUARDS MUST REMAIN IN PLACE FOR SAFE CUTTING OPERATON.

NOTE:

This manual is not totally comprehensive. It does not and cannot cover every possible safety and operational factor which may arise during the life of the machine.

Modifications:

- • Any modifications to the machine including incorporation into an assembly, addition of integrated feeds or other changes are the responsibility of the end user and the end user must ensure ongoing compliance.

Additional Safety Actions to be Taken by End User

- • Lock out Tag out procedures to be adopted during all maintenance.
- • Lock out Tag out procedures to be observed when changing blade

Functional Testing

- • Braked run down times test—tested monthly (30 second brake run down)
- • Upper Guard locking—tested monthly, prove there is an inability to open upper guard without tools.
- • Test lower ring guards test to make sure it moves freely, they are not bent, and does not hang up—must drop freely to lower portion of blade

Instructions for Use:

- • Always observe the safety instructions and applicable regulations.
- • Ensure the material to be sawn is firmly secured in place.
- • Apply only a gentle pressure to the tool and do not exert side pressure on the saw blade.
- • Avoid overloading.
- • Install the appropriate saw blade.
- • Do not use excessively worn blades.
- • The maximum rotation speed of the tool must not exceed that of the saw blade.
- • Do not attempt to cut excessively small pieces.
- • Allow the blade to cut freely. Do not force.
- • Allow the motor to reach full speed before cutting.
- • Make sure all locking knobs and clamp handles are tight.
- • Never run the machine without the guards in place.
- • Never lift the machine by the table top.

Preventative Maintenance

Original Radial Arm Saws are designed to provide you with precision cutting with a minimal amount of maintenance. The frequency of the maintenance depends on the amount of use and the desired cutting quality.

Always disconnect and lockout power supply before performing maintenance.

Daily

- • Wipe down the machined tracks in the arm, this will prevent wood pitch buildup on the machined surfaces
- • Dust off and remove excess saw dust

Monthly

- • Repeat daily tasks but use denatured alcohol or paint thinner to wipe down tracks
- • Remove arbor nut, collars, and saw blade. Inspect the saw blade teeth for sharpness and broken tips. Replace or re-sharpen as necessary
- • Remove end cap and remove carriage and rest on the table (do not remove wiring) then wipe off the bearings with denatured alcohol or paint thinner to remove all wood pitch buildup, DO NOT lubricate the tracks this will cause premature track wear due to sawdust sticking to the tracks.
- • Inspect arbor, are the arbor bearings still tight and free of play? If not then they will need to be replaced by a technician or at a electric motor shop.
- • Inspect all wiring to check for cracks, replace if worn or cracked.
- • Using compress air blow out the cooling ducts in the motor by blowing through from the arbor side of the motor to the back of the motor, (use Personal Protection equipment ie safety glasses and a face mask to protect from the dust)
- • Dust off all surfaces using a vacuum remove all saw dust from the table and the frame.

MANTAINENCE RECORDS









Preventative Maintenance ... Continued

- • After many years of use your saw may need replacement parts. If any of the following wears out all others listed should be checked also.
- • Roller head bearings: Check for free, smooth rotation. Do not attempt to lubricate.
- • Arm Tracks: If the saw is used primarily for short cut-offs, the tracks may wear making it difficult to adjust the roller head bearing for full length arm travel. Arms can generally be re-machined—contact Original Saw for pricing and shipping instructions.
- • Motor bearings: Check for free, smooth rotation. Do not attempt to lubricate.
- • Elevating mechanism: Remove, clean and lubricate with type EP grease. Check for wear between nut and jack screw. Replace assembly if loose.

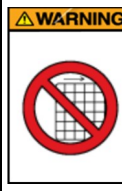
Use this space to record service or use page 2 for a more detailed recording for your Original radial arm saw.



SYMBOLS / DECALS

1		Denotes risk of injury, loss of life, or damage to the tool in case of not observing the instructions in this manual.	6		Denotes hearing and eye protection required.
2		Denotes risk of electrical shock.	7		Denotes guards required to be in place.
3		Denotes risk of pinching hazard.	8		Denotes general safety hazard. See operators manual for more information pertaining to these areas.
4		Denotes hazard of rotating blade.	9		Denotes lift point.
5		Denotes hazard of entanglement.			

Always replace damaged, missing, or illegible decals. Contact Original Saw at 641.843.3868 for replacement parts.

SYMBOLS / DECALS



Caution
3 denotes a pinch point between
bevel stop and roller head
5 denotes hand entanglement
with spring return cable.

Arm:
- General Caution

ARM:
- Caution , do no oper-
ate with safety stop re-
moved

Danger
2 Hazardous
Voltage

Caution
E-stop yellow Surround
back plate

Guard:
Index # 4 Hazzard Rotating blade
6 Hearing and eye protection
7 Guards required to be in place
- Do Not rip or plough from this
end
- rotation direction
- use blades rated at 3600 rpm

Frame:
Index # 9 Denotes lift point
Note there are 2 on front of frame
and 2 on the rear of the frame



Components and Controls

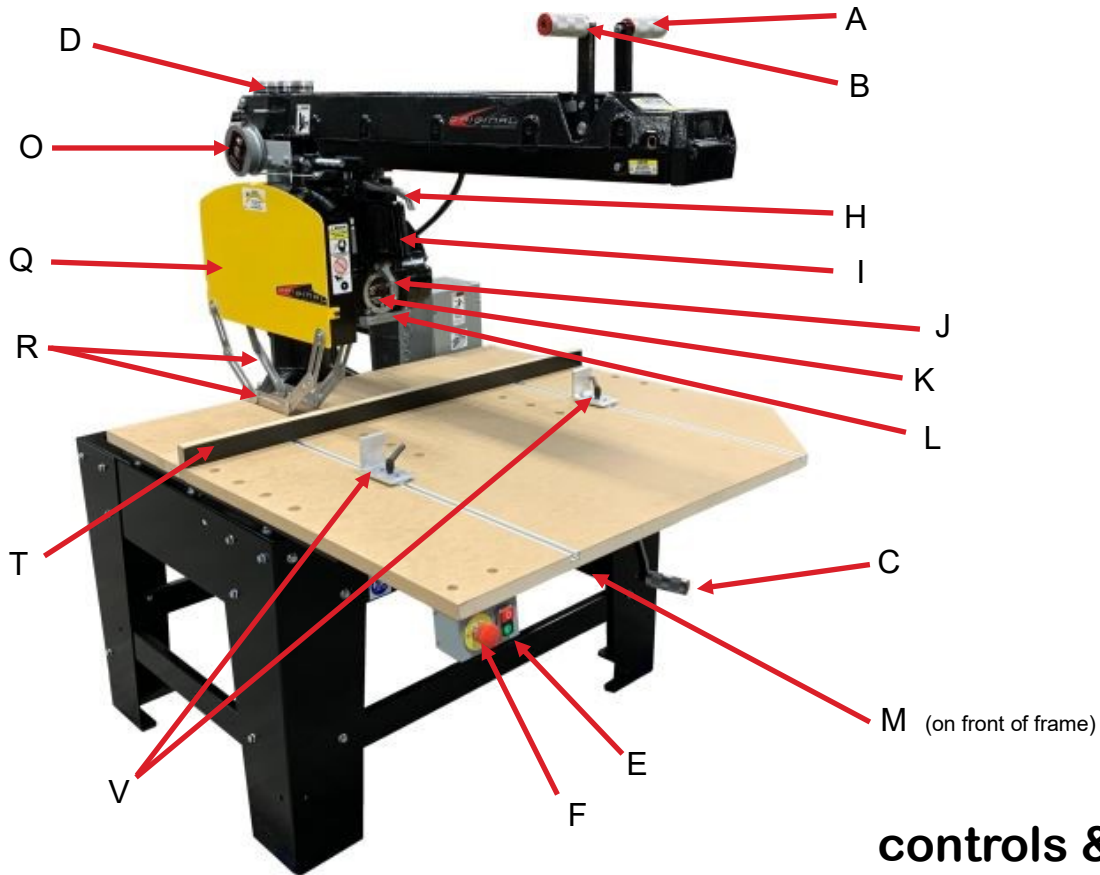

controls & components locations

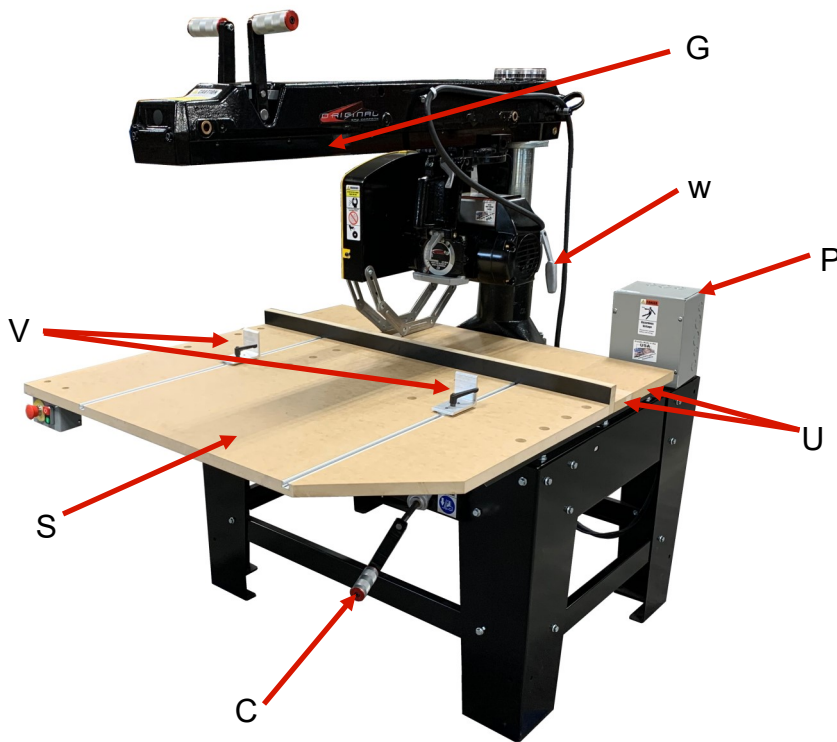

- A. Miter Latch Handle
- B. Arm Clamp Handle
- C. Elevating Control Handle
- D. Miter Scale
- E. On/Off Switch
- F. E-stop
- G. Adjustable Arm Stop (not shown attaches on this side of the arm)
- H. Swivel index handle
- I. Operating Handle
- J. Bevel Index handle
- K. Bevel Scale
- L. Bevel Clamp Handle
- M. Serial Number Plate (on front of frame)
- N. Carriage lock clamp
- O. Carriage return spring
- P. Magnetic starter assembly (Usually mounted on wall)
- Q. Blade guard (upper)
- R. Blade guard (lower) 2 pcs
- S. Front table
- T. Fence board
- U. Spacer boards
- V. Manual clamp stops
- W. Base Clamp handle

PRODUCT SPECIFICATIONS

20 inch / 508 mm 3 phase 3553 / 3558

SD Series

Standard equipment:

Machine, Complete upper and lower blade guard, carriage return attachment wrench kit, magnetic starter with overload/ low voltage protection, low voltage start/stop station, oversized MDF table top, heavy gage steel frame and leg stand with leg braces

GENERAL SPECIFICATIONS

Manufacturer	Original Saw Company
Electrical drawing	121239-75
Enclosure rating	IP65
Material to be cut	Wood products / plastics only
Stock sizes to be cut 3553.....	up to 23" wide x 6" thick
Stock sizes to be cut 3558.....	up to 31" wide x 6" thick

		3553	3558	3553-575	3558-575
Motor Power (output continuous)	HP / W	7.5 / 5592	7.5 / 5592	7.5 / 5592	7.5 / 5592
Voltage	V	208, 230, 460	208, 230, 460	500-600	500-600
Fuse	Amp	40	40	20	20
Blade Diameter max	Inches / mm	20 / 500	20 / 500	20 / 500	20 / 500
Blade Bore	Inches / mm	1 / 25.4	1 / 25.4	1 / 25.4	1 / 25.4
Spindle Diameter	Inches / mm	1 / 25.4	1 / 25.4	1 / 25.4	1 / 25.4
No load spindle speed 50Hz	rpm	2825	2825	2825	2825
No load spindle speed 60Hz	rpm	3400	3400	3400	3400
Brake time	seconds	25	25	25	25
Depth of cut at 90°	Inches / mm	6.25 / 158	6.25 / 158	6.25 / 158	6.25 / 158
Depth of cut at 45°	Inches / mm	3.25 / 82	3.25 / 82	3.25 / 82	3.25 / 82
Max crosscut capacity at 0° @ 3/4"	Inches / mm	24 / 610	32 / 812	24 / 610	32 / 812
Max Miter cut capacity at 45° @ 3/4"	Inches / mm	16 / 400	21.625 / 549	16 / 400	21.625 / 549
Max rip cut width	Inches / mm	Not applicable	Not applicable	Not applicable	Not applicable
overall dimensions (with legs)	Inches / mm	60" x 46" x 44" 1520x1190x1117 mm	60" x 46" x 44" 1520x1190x1117 mm	60" x 46" x 44" 1520x1190x1117 mm	60" x 46" x 44" 1520x1190x1117 mm
Dust extraction adapter (optional equipment)	Inches / mm	4 / 100	4 / 100	4 / 100	4 / 100
Weight	Lbs / kg	900 / 408	900 / 408	900 / 408	900 / 408

PRODUCT SPECIFICATIONS

22.5 inch / 550 mm 3 phase 3554 / 3559

SD Series

Standard equipment:

Machine, Complete upper and lower blade guard, carriage return attachment wrench kit, magnetic starter with overload/ low voltage protection, low voltage start/stop station, Extruded aluminum T-slot table w/ HDPE fence, heavy gage steel frame and leg stand with leg braces

GENERAL SPECIFICATIONS

Manufacturer	Original Saw Company
Electrical drawing	121239-75
Enclosure rating	IP65
Material to be cut	Wood products / plastics only
Stock sizes to be cut 3554	up to 16" wide x 8" thick
Stock sizes to be cut 3359	up to 24" wide x 8" thick

		3554	3559	3554	3559
Motor Power (output continuous)	HP / W	7.5 / 5592	7.5 / 5592	7.5 / 5592	7.5 / 5592
Voltage	V	208, 230, 460	208, 230, 460	500-600	500-600
Fuse	Amp	40	40	20	20
Blade Diameter max	Inches / mm	22.5 / 550	22.5 / 550	22.5 / 550	22.5 / 550
Blade Bore	Inches / mm	1 / 25.4	1 / 25.4	1 / 25.4	1 / 25.4
Spindle Diameter	Inches / mm	1 / 25.4	1 / 25.4	1 / 25.4	1 / 25.4
No load spindle speed 50Hz	rpm	2825	2825	2825	2825
No load spindle speed 60Hz	rpm	3400	3400	3400	3400
Brake time	seconds	25	25	25	25
Depth of cut at 90°	Inches / mm	8 / 203	8 / 203	8 / 203	8 / 203
Depth of cut at 45°	Inches / mm	4 / 100	4 / 100	4 / 100	4 / 100
Max crosscut capacity at 0° @ 3/4"	Inches / mm	22 / 560	30 / 760	22 / 560	30 / 760
Max Miter cut capacity at 45° @ 3/4"	Inches / mm	16 / 400	21.625 / 549	16 / 400	21.625 / 549
Max rip cut width	Inches / mm	Not applicable	Not applicable	Not applicable	Not applicable
overall dimensions (with legs)	Inches / mm	1520x1190x1117	1520x1190x1117	1520x1190x1117	1520x1190x1117
Dust extraction adapter (optional equipment)	Inches / mm	4 / 100	4 / 100	4 / 100	4 / 100
Weight	Lbs / kg	425 / 193	425 / 193	425 / 193	425 / 193

ANSI Conformance

Intended Use of Machine

- Machines for Wood and plastic cutting only
 - Maximum size of material
 - 3553/ 3558 width 23 / 31" depth 6.25"
 - 3554/ 3559 width 23 / 31" depth 8"
-

Residual Risks

The following risks are inherent to the use of radial arm saws:

In spite of the application of the relevant safety regulations and the implementation of safety devices, certain residual risks cannot be avoided.

These are:

- Impairment of hearing.
 - Risk of accidents caused by contact with the uncovered parts of the rotating saw blade.
 - Risk of injury when changing the blade.
 - Risk of pinch hazard between base and carriage of machine.
 - Health hazards caused by breathing dust developed when sawing wood, especially oak, beech, MDF.
-

Dust / Chip Collection

End user must ensure that the machine is installed in a well ventilated area with chip and dust extraction system fitted to the extraction points

- The machine is set for indoor use only and must be connected to a dust/chip collection system.
 - The dust collection system must be switched on before cutting operations can begin.
 - The hoses on the dust collection must be grounded to PE
 - There are dust collection shrouds available as accessories please call customer service at 641-843-3868 or email customerservice@originalsaw.com with any questions
-

Eye Protection

- Eye protection must be worn at all times during use.
-

Trip / Slip Hazard

- Make sure power cable is routed in a manner to ensure there is no trip / fall or a slip hazard
 - Keep work area around saw clean and free of hazards.
-

ANSI-Declaration of conformity

3553/3558-03-208/230, 3553/3558-03-460, 3553/3558-03-575/600, 3554/3559-03-208/230, 3554/3559-03-460, 3554/3559-03-575

Original Saw declares that these power tools have been designed in compliance with ANSI Machine Standards 01.1-2013. For more information, please contact Original Saw at the address below or refer to the address on back of the manual.

Noise Exposure

- It is the responsibility of the installer and end user to ensure The Noise Exposure requirements of 29 CFR 1910.95 are satisfied.

3553/3558-03-208/230, 3553/3558-03-460, 3553/3558-03-575/600, 3554/3559-03-208/230, 3554/3559-03-460, 3554/3559-03-575

LpA (sound pressure) dB(A)* 85.5 85.5

LWA (acoustic power) dB(A) 93.5 93.5

* at the operator's ear

Take appropriate measures for the protection of hearing if the sound pressure of 85 dB(A) is exceeded.

Original Saw Company

465 Third Ave SE

Britt, IA 50423

PH 641-843-3868 FX 641-843-3869

e-mail: customerservice@originalsaw.com

Blades

- Use only blades that are rated at the specified 3600 RPM when machine is operate at 60Hz or 2825 when machine is operated on 50 Hz the RPM on the machine guard no blade shall be used that is not rated for the rpm of the machine.
-

Lighting requirements

- The area around the machine must be well lit.
-

SAW ASSEMBLY AND INSTALLATION

UNPACKING YOUR SD SERIES SAW

Your Super Duty series saw system has been completely assembled, tested, and then partially disassembled. The shipment of your saw contains the following items:

- The Super Duty Series Saw, (4) frame legs, arbor wrenches, allen hex wrench kit, hardware to attach legs.

Your machine will be banded down to a shipping skid with the legs removed and packaged under the table top. To uncrate simply remove the corners and the framing from the skid and cut the bands that hold the saw to the skid. The unit can then be picked up with a forklift under the steel frame and then the legs can be installed using the 3/8 bolts, lock washers, and heavy hex nuts. If you purchased extension tables the brackets can be also added at this time.

Install bolts finger tight and place machine where it is to be set up then tighten legs this will allow machine to level itself to the floor.

Important

All cable lengths have been adjusted during manufacture to allow for proper movement of the arm and rollerhead. However, you should check the cables to ensure full range of movement. If adjustment is necessary, loosen the cable clamp (at right rear of arm) and adjust the cables so rollerhead is free to travel the total length of the arm with the motor pivoted in the roller head so the blade is on the right hand side. Also, check to ensure there is enough slack in the cables between the rear of the arm and the starter enclosure so the arm can be swung to the right a full 90° while the arm is elevated to its highest position.

FLOOR MOUNTING DIMENSIONS

Your saw may be mounted to the floor using 1/2" diameter hardware appropriate for the floor surface and located according to the diagram to the right. All dimensions are center-to-center.

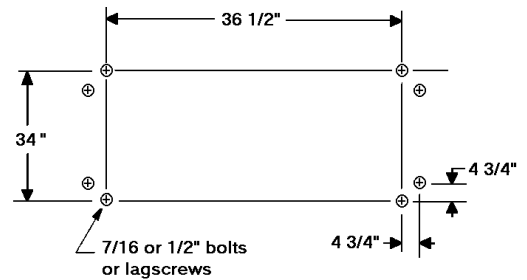

Connecting Electrical Current

The motor is properly connected to the magnetic switch at the factory for operation on the electrical voltage specified. Make sure incoming voltage from your power supply conforms to the voltage specified on the cover of magnetic starter.

Remove the magnetic switch cover and insert power supply cable through the dust proof fitting. Connect wires to L1, L2 and L3 for 3 phase; L1 and L2 for single phase (See page photo). Do not attach power to the transformer. Attach the ground wire to the ground lug inside starter enclosure. Wiring must conform to the National Electrical Code and any applicable local codes.



SAW ASSEMBLY AND INSTALLATION

Check Arbor Rotation (3 Phase Only)

Check arbor rotation with arbor nut and arbor collars removed. Open line disconnect to the saw to remove arbor nut and collars, close the line disconnect and start saw. The rotation of the arbor must be clockwise as indicated on the arrow on the nameplate. If the rotation is counter-clockwise, the incoming wires are not properly connected to the switch box. To change the direction reverse any two of the wires leading to the switch box from the power supply.

Changing Voltage on dual voltage motors and Resetting Thermal Protection

Dual voltage motors can be operated on either of the two voltages indicated on the motor nameplate. The voltage setting from the factory can be found on the cover of the magnetic starter. To change the voltage:

1. Change the motor lead connections as shown on the diagram on the inside cover of the motor conduit box. This is also found on page 23 in this manual. Disconnect and lockout the power supply before attempting voltage change.
2. Reconnect the transformer in the magnetic starter as shown in the diagram on the inside of the starter box cover. This is also found on pages 23 of this manual.
3. Replace or adjust the thermal overload protectors (D) using dial (A), see below right) with those rated at the desired amperage range. See page 23 of this manual. If the overloads trip you will need to press reset button (C) to resume operation.

Overload Protection

Your saw is equipped with automatic reset thermal overload protection. To restart after thermals have tripped, wait until the motor cools, then press the saw start button. If overloads continue to trip, the machine is being overloaded. Do not continue to operate under these conditions. This could indicate an electrical problem take the time to find the trouble and correct it, see the electrical trouble shooting section of this manual.

Control Panel layout and components

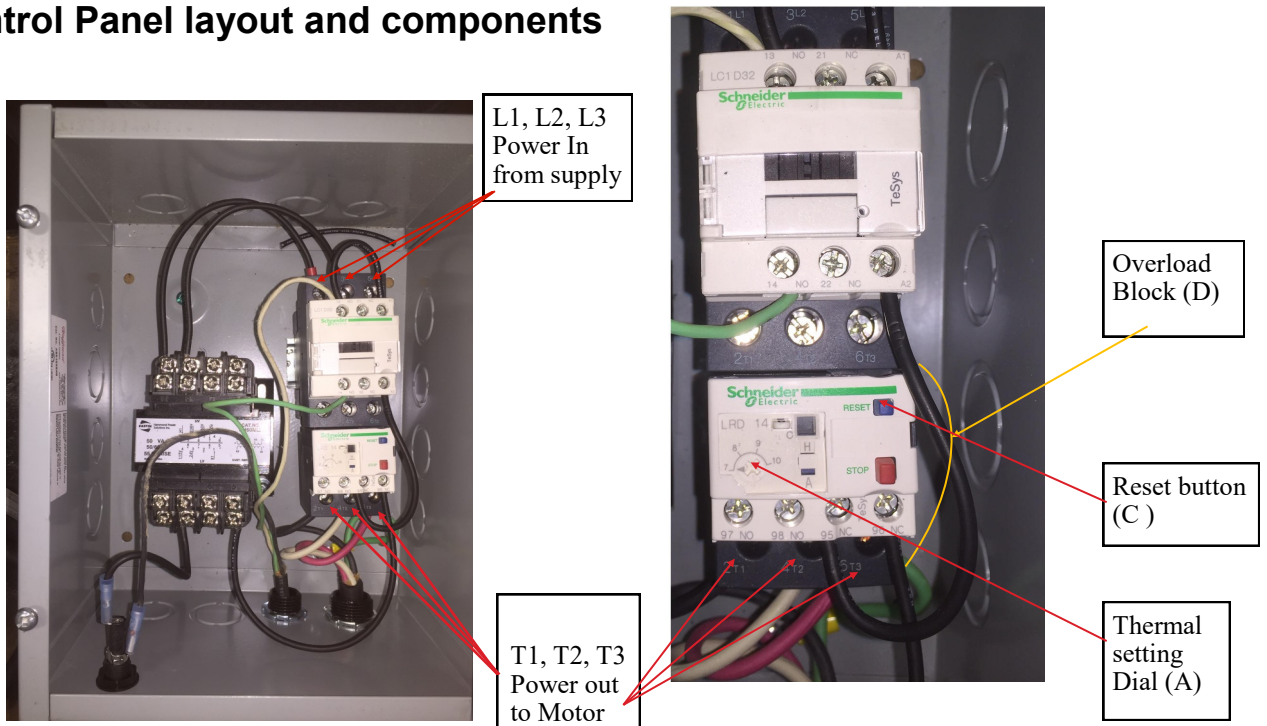

SAW ASSEMBLY AND INSTALLATION

Saws equipped with Variable Frequency Drives (VFD)



Connecting Electrical Current

The motor is properly connected to the VFD at the factory for operation on the electrical voltage specified. Make sure incoming voltage from your power supply conforms to the voltage specified on the cover of VFD enclosure.

Remove the VFD enclosure cover and insert power supply cable (customer supplied hole). Connect wires to R/L1, S/L2 and T/L3 on terminal strip for 3 phase; Do not attach any wire to N/-. Attach the ground wire to the ground lug (G) inside enclosure. Wiring must conform to the National Electrical Code and any applicable local codes.



Ground Lug

R/L1 S/L2 T/L3





Recommend Copper Wire Sizes (A.W.G.)

To obtain maximum efficiency from your saw motor, the feeder wire from the power source to the machine should comply with the table below. Always follow NEC rules and guidelines along with local AHJ.



Note: Always check arbor shaft rotation before installing blade, arbor nuts, or collars.

Wire sizes in this chart are the result of high start up amps.

Recommended Copper Wire Sizes

<u>Up to 60' from power supply</u>	1 Phase	3 Phase	3 Phase	3 Phase
	200-240 V	200-240 V	440-480 V	550-600 V
3 hp	#8 AWG	#8 AWG	#10 AWG	#10 AWG
5 hp	#6 AWG	#8 AWG	#10 AWG	#12 AWG
7.5 hp	N/A	#6 AWG	#8 AWG	#10 AWG

<u>60 - 100' From power supply</u>	200-240 V	200-240 V	440-480 V	550-600 V
	3 hp	#6 AWG	#6 AWG	#8 AWG
5 hp	#2 AWG	#6 AWG	#6 AWG	#8 AWG
7.5 hp	N/A	#4 AWG	#6 AWG	#6 AWG

<u>100 - 160' From power supply</u>	200-240 V	200-240 V	440-480 V	550-600 V
	3 hp	#4 AWG	#4 AWG	#6 AWG
5 hp	#0 AWG	#2 AWG	#6 AWG	#6 AWG
7.5 hp	N/A	#2 AWG	#4 AWG	#6 AWG

<u>Over 160' From power supply</u>	200-240 V	200-240 V	440-480 V	550-600 V
	3 hp	#2 AWG	#2 AWG	#4 AWG
5 hp	#00 AWG	#2 AWG	#2 AWG	#4 AWG
7.5 hp	N/A	#0 AWG	#2 AWG	#2 AWG

Note: Wire too large to insert into the provided magnetic starter will need to be terminated in a fused disconnect and #10 wire ran into the magnetic starter using less than 10 feet of cable.

Recommended Fuse / Breaker Size

(Located in the disconnect enclosure)

	1 Phase	3 Phase	3 Phase	3 Phase
	200-240 V	200-240 V	440-480 V	550-600 V
3 hp	60 AMP	20 AMP	20 AMP	20 AMP
5 hp	90 AMP	30 AMP	20 AMP	20 AMP
7.5 hp	N/A	45 AMP	20 AMP	20 AMP

SAW ASSEMBLY AND INSTALLATION



!Caution disconnect / lock out power source before mounting blade!

!!! CAUTION !!!

FOR ILLUSTRATION PURPOSES ONLY, THE GUARDS HAVE BEEN REMOVED FOR THE PHOTOS USED IN THIS MANUAL. IN ACTUAL USE BOTH UPPER AND LOWER GUARDS MUST REMAIN IN PLACE FOR SAFE CUTTING OPERATION.

**Guard Mounting note guard is installed when machine is shipped
(Caution! Disconnect/lockout power source before mounting guard)**

1. Loosen the 1/4" x 20 allen head bolts in front and back of guard. Remove wing nut and washer from top of guard.
2. Remove the front guard cover by sliding guard cover out and lifting up.
3. Mount blade. (Follow mounting blade instructions.)
4. Replace outer guard sliding over stud on top of inner guard. Then sliding behind allen head bolts and retighten.
5. Now attach lower links with supplied hardware, both inner and outer.

Caution: Your saw is now ready to use. Before using it, study the control locations, cautions and operating instructions contained in the following pages.

Mounting the Blade (Caution! Disconnect power source before mounting blade)

1. Place the hex box wrench over the arbor nut and place the long allen wrench in the arbor shaft end hole. Place a wood striking block under the allen wrench to avoid marring the tabletop. Push down on the hex wrench to loosen nut (left hand thread). (See figure 2)
2. Remove the nut and first arbor collar. Wipe the arbor collar faces and mounting area on the blade. Slide the blade on the shaft with the directional arrow away from the motor and pointing clockwise.
3. Place the arbor collar, recessed sides against the blade, arbor nut and tighten securely. (See figure 1)

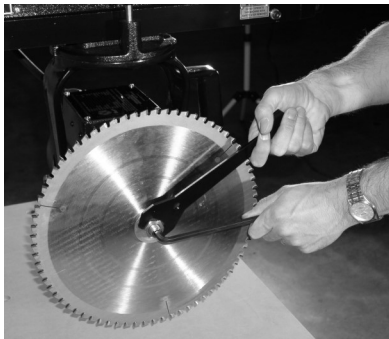

FIGURE 1

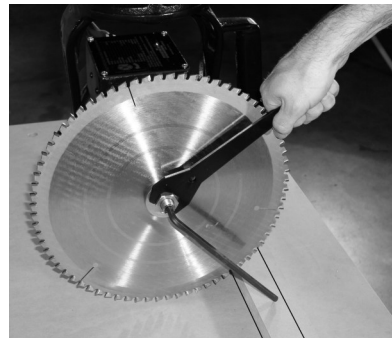

FIGURE 2



Operating Instructions

General Safety Precautions

1. Be sure the blade rotates clockwise when facing the saw from the left side. Blade must rotate to the front of the saw.
2. Be sure all clamp handles are tight before turning motor on.
3. Keep the blade sharp and properly set.
4. Hold material firmly against the guide strip when cutting.
5. Be sure the blade and arbor collars are clean and the recessed side of the collars are against blade.
6. Never oil or grease arm trackways or motor.
7. Do not start machine without proper tool guard.
8. Do not remove the anti-kickback device from the blade guard. Adjust it to just clear the work. If applicable.
9. Keep motor air slots clean.
10. Return roller head to full rear after each operation.

General Cautions When Using the Lower Blade Guard:

1. The lower blade guard will provide protection from contact with the side of the blade. It is not designed to prevent contact with the front or rear of the blade. When the lower guard contacts the fence or material being cut it will rise up exposing the blade. Be careful to keep your hands out of the line of the cut.
2. Lower blade guards may become caught in prior kerfs in the fence or table. Replace guide fence frequently. If guard becomes caught stop saw before attempting to remove.
3. Short cut-off pieces of wood may become caught between the lower guard and the blade. If this happens shut off the saw and wait until blade stops to remove the piece.
4. The lower blade guard's effectiveness is limited in bevel operations. It may have to be raised out of the way when setting the bevel angle. **Be sure the power is off/locked out and blade is completely stopped before making any adjustment.**
5. Catching the lower guard in saw kerfs when changing the saw setup can be avoided by elevating the saw until the bottom of the guard clears the fence.
6. When ripping narrow strips the lower guard may have to be raised to rest on top of the guide fence. Be sure to use a pusher stick to feed the work.
7. Do not use the lower guard with any accessory other than the correct size blade.

Using the Adjustable Rollerhead Stop

The rollerhead stop should be used whenever rollerhead travel needs to be limited for example when repetitive cross cuts are being made. Use of the rollerhead stop will also prevent the blade from throwing small cut off pieces on the return stroke. **Do not adjust the rollerhead stop unless the power is off and locked out and the blade stopped. The rollerhead stop must be used on the right side of the arm.** Proper adjustment of the rollerhead stop is completed as follows:

1. Pull the rollerhead forward far enough for the blade to sever the material and travel 1/4" past the material.
2. Lock the rollerhead to the arm with the riplock and place the rollerhead stop so it is touching the rollerhead and tighten the knob.
3. Loosen the riplock and return the rollerhead behind the fence.

Operating Instructions

Alternate Guide Strip Positions

Your saw was assembled with the guide strip in the most frequently used position on the work table (see figure 3). The guide strip may be moved to alternate positions to accommodate varying uses. Moving the guide strip behind the spacer board will allow for maximum cross cutting capabilities. Moving the guide strip back to the rear board will provide for maximum ripping capability.

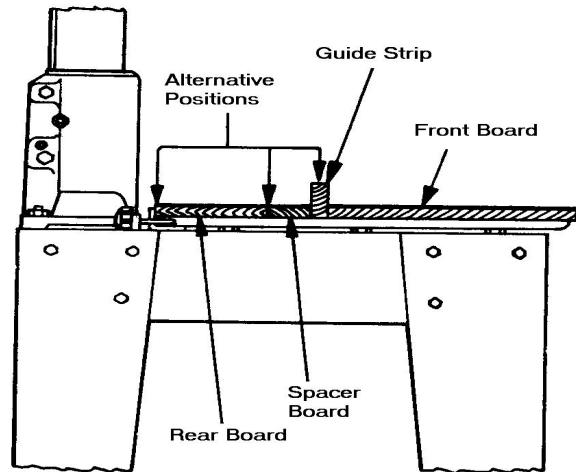

Figure 3

Table Setups for Heavy Duty Cutting

If the depth of cut exceeds 1 5/8" it is advisable to replace the original guide strip with a higher fence. Make a 5/8" x 15/16" notch in a straight 2 x 4; remove the original guide strip and replace with the notched 2 x 4. If a greater depth of cut is desired or a larger diameter blade is used attach a spacer to the 2 x 4 fence. Be certain all spacer fasteners are clear of saw kerfs. (See figure 4.)

When making heavy cuts high above the table, such as rafter notching or dado cutting, the following setup is suggested. Replace the spacer board and the guide strip with 2 straight 2 x 4's or 2 x 6's. Attach several gusset boards to the rear 2 x 4 or 2 x 6 to back up the fence. (See figure 4.)

Table Clamps

The table clamps are manually adjusted. If it is desired to insert a 2 x 4 or 2 x 6 on its narrow side as a fence, remove the existing spacer board, and use the guide strip as a back up for the high fence

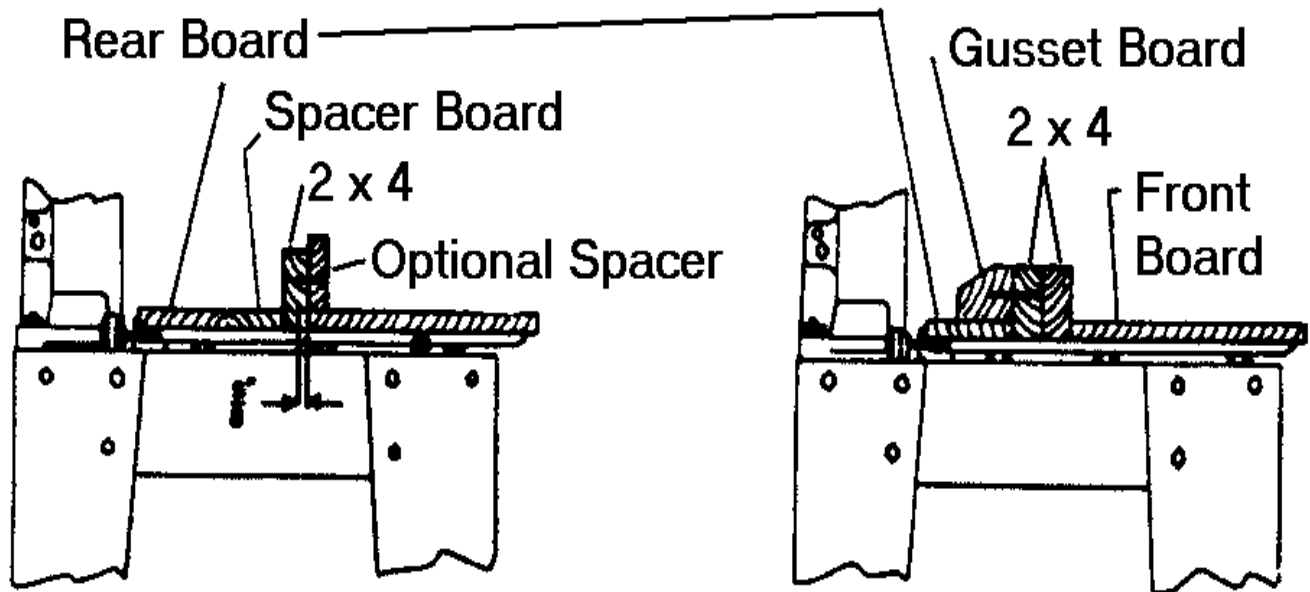

Figure 4

Operating Instructions

standard manual clamp / material stop continued

During operations where the arm is swung left or right could put the clamp in the path of the blade. If this is going to happen simply add scrap board that will allow the clamp to be moved further out on the table and clear the blade path. (Red arrow 1)

Inset photo: Also pay attention to the clamping handle and clearance to the lower guard making sure the clamp does not obstruct the guard and hand up, simply pull the handle gently and rotate the grip out of the way. (Red arrow 2)

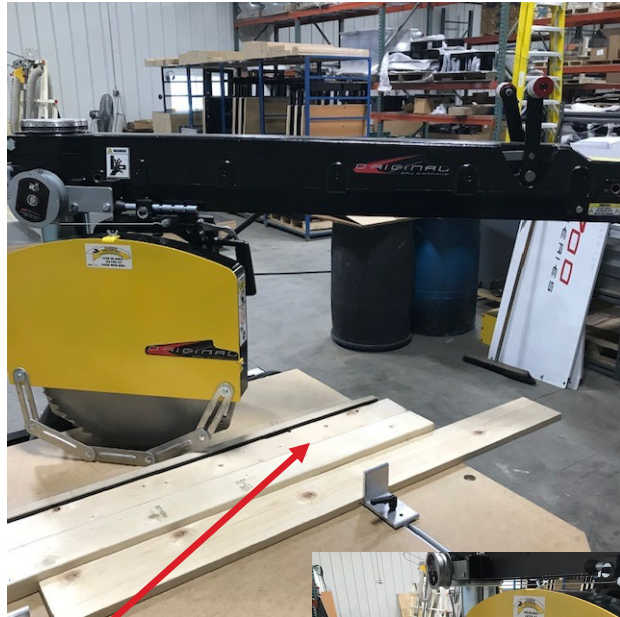

1



2

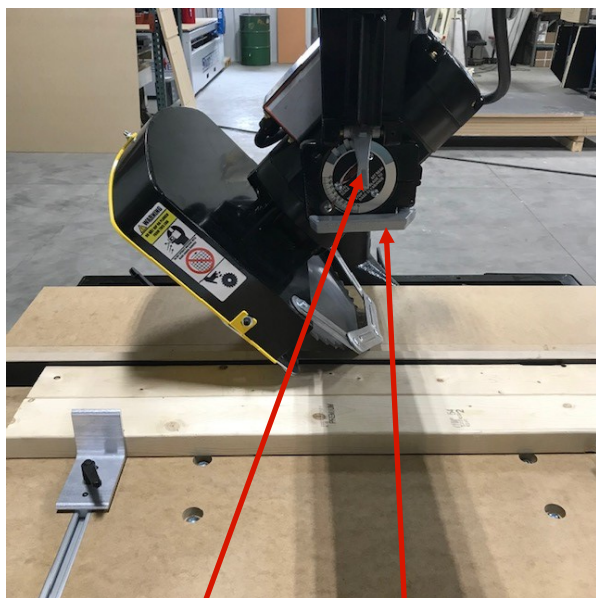

Bevel Latch

Bevel Clamp

Revolving the Motor Vertically in the Yoke



Raise the arm to allow the saw blade sufficient clearance above the table top. Release the bevel clamp handle, grasp the saw guard with the left hand and lift the bevel latch handle. The motor can now be swung to a bevel position as indicated on the bevel scale. Lock the motor by engaging the bevel latch handle (possible only at 0°, 45° and 90°) and by locking the bevel clamp handle.

Operating Instructions



Raising and Lowering the Arm

When the column clamp handle is pulled forward, the elevating crank can be used to raise or lower the arm. Using the elevating scale and the indicator on the elevating crank, the desired depth of cut can be adjusted. Each calibration (1/8 turn) on the elevating scale raises or lowers the arm 1/64", therefore, one full turn of the elevating crank moves the arm exactly 1/8", one half turn exactly 1/16". The elevating crank can be removed by loosening the set screws but should be left on to avoid

To Revolve the Arm Horizontally

To change the position of the arm, pull both the miter latch handle and the arm clamp handle forward. Observing the miter scale, swing the arm either right or left to the desired angle. The arm can quickly be located at the 0 and 45 degree marks by using the locator slots machined into the column ring. When you have located the saw at the required position engage both the miter latch and the arm clamp by pushing the handles back.



standard manual clamp / material stop

New standard manual clamp / material stops are provided on the left and right side of the blade to keep the material being cut from sliding and keep the operator's hand away from the blade. To use simply loosed the clamping handle slid up against the material to be cut and while keeping pressure against the material tighten the clamping handle.



Operating Instructions

Cross Cutting



Lock the arm in the 0° position. Place the material securely against the guide strip— keep hands well away from the blade. Draw the saw blade across the material. After the cut has been completed return the blade behind the guide strip. Observe this order of operation for all cross cuts. Never push the saw blade into the material. Pull the blade slowly and firmly across the material from the rear of the arm using the operating handle. The saw blade should cut into the table about 1/16" when cutting through the material. Raise the anti-kickback (when installed) to just clear the material being cut. Adjust for varying wood thickness or warped material.



Bevel Cutting



Lock the arm in the cross cutting position. Raise the motor by rotating the elevation crank. Release the bevel clamp and the bevel latch and tilt the motor in the yoke. The bevel angle is shown on the bevel scale. Lock the bevel latch and clamp. Lower the arm into cutting position. Adjust the bevel stop to assure clearance between blade and base. Pull the saw through as you would for cross cutting. Make sure rear of blade as clearance between it and base. (Page 28)

Compound Miter Cutting



The compound miter is merely a combination of the bevel cut and the miter cut. Set up the machine for bevel cutting. Release the arm clamp handle and the miter latch handle. Swing the arm into the required position and lock the miter latch and arm clamp. Adjust bevel stop to assure clearance between blade and base. Pull the blade through as you would for cross cutting.

Note: pay attention to blade to clamp clearance See Clamps section to allow for clamp clearance on miter cuts. (Page 22)



Maintenance Adjustments and Alignments



Caution! Disconnect and lockout power supply before making any adjustments

Your saw has been completely assembled, aligned and tested at the factory...then partially disassembled for shipment. Handling during shipment may cause some misalignment and the following information will enable you to correct any cutting inaccuracy you discover. These adjustments may also be necessary after a period of use. (See preventive maintenance)

Adjustment of Base to Column Fit

If excessive side motion exists at the end of the arm when the arm clamp is engaged and the column clamp is released, adjustment to the base or bronze gib is generally necessary. To adjust:

1. Loosen all locknuts, set screws and bolts and pull column clamp handle forward.
2. With the motor and yoke in the rearmost position the elevation effort should be easy.
3. Tighten the bottom pinch bolt (A) until there is an increase in the elevation effort. Bottom the jack screw (B) against the opposite side of the slot; this will lock the pinch bolt.
4. Tighten the gib screw (C) hard, then back it off. Run it back up against the gib lightly, then snug up the locknut (D).
5. With the column clamp handle in the forward position insert a 1/4" allen wrench into column clamp bolt (E) and turn it clockwise until all play is removed from the column clamp handle. Lock the handle adjustment by tightening the bolt (F) on the opposite side of the base.

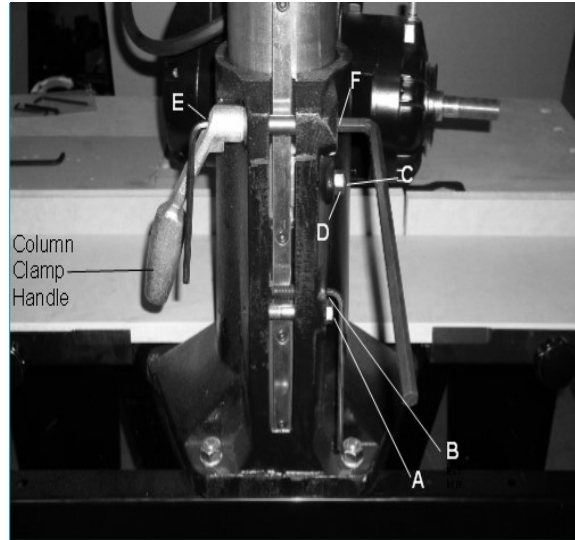

Adjustment of the Arm Clamp

If the arm will not clamp tight on the column:

1. Place motor carriage in the rearmost position.
2. Pull the miter handles (A) forward.
3. Tighten upper arm pinch bolt (B) until slight resistance to arm swing is felt.
4. Swing the arm to the left 10° until the two locking set screws (C) are aligned with an oblong hole in the bottom of the column collar (D).
5. Loosen the two set screws.
6. Use a 1/4" allen wrench to tighten the arm clamp screw (E) by rotating clockwise.
7. Retighten the two locking set screws securely to a required torque of 200-225 inch/ lbs. They must be tight to prevent clamp screw slippage.

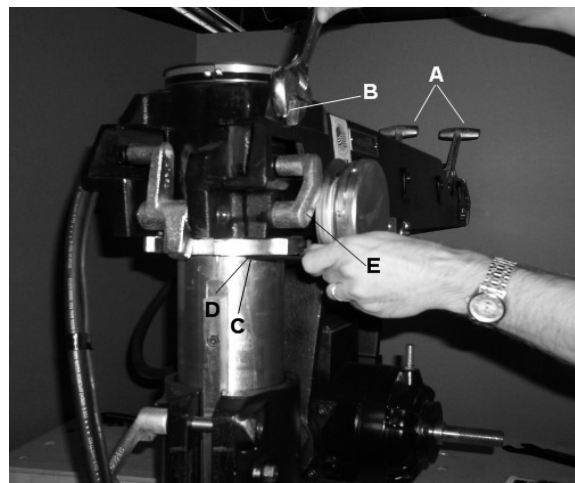

Maintenance Adjustments and Alignments

Caution! Disconnect and lockout power supply before making any adjustments or alignments.

Adjustment of the Rollerhead to Arm

Accurate work cannot be done if the roller bearings of the motor carriage are not in proper adjustment. When play develops between the rollerhead and the arm the following adjustment is required:

1. Remove the arm end cap by taking out the two socket head cap screws in the front of the end cap.
2. Clean the tracks thoroughly. Wipe them clean with a solvent, **do not** use kerosene. Use extreme caution as most solvents are toxic and/or flammable. **Do not** grease or oil the tracks.
3. Loosen the locking set screws (A) on the two left hand 45° bearings (C) just enough to loosen them (1/6 of a turn or less).
4. Using a 1/4" allen wrench and a light behind the rollerhead, adjust the eccentric studs (B) on the left-hand side bearings until all 8 bearings contact the track. Attempt to equalize the load on the front and rear bearings by putting the same load on the front and rear eccentrics.
5. Retighten the locking set screw securely to a required torque of 90-100 inch/lbs., after adjusting each eccentric.
6. Replace the end cap
7. If any of the top rollers do not revolve when in contact with the top track it will be necessary to remove the entire carriage to closely check each roller bearing. If bearings do not revolve, and thorough cleaning doesn't make them all free to revolve, the defective ones should be replaced.

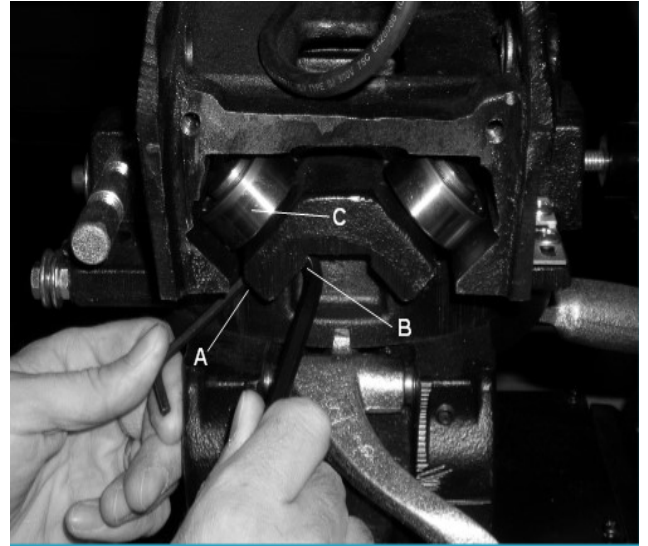

Note-Too much pressure on the roller bearings will cause excessive and unnecessary wear in the parts and make the carriage work harder. Seven to ten pounds average pull on the carriage is a desirable preload.

Adjustment of the Yoke Clamp Nut

If the yoke clamp nut (A) becomes too loose the following steps will correct this condition:

1. Tighten nut (A) counter clock wise until yoke is tight.
2. You should always check your saw for accuracy after any adjustments. (Refer to pages 25,26,27)

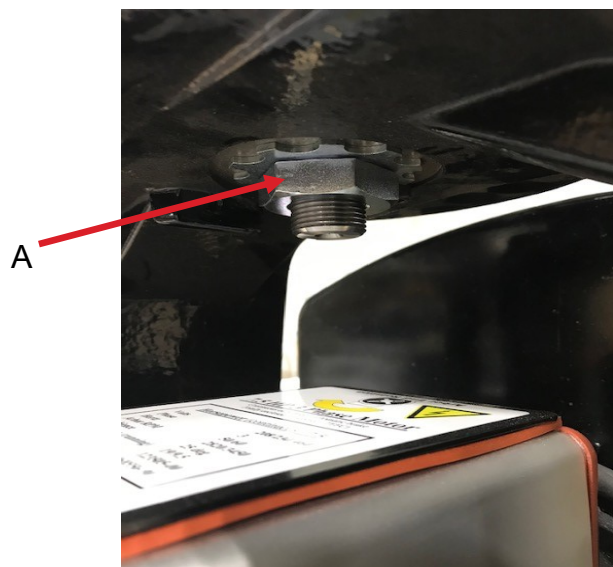

Maintenance Adjustments and Alignments

Caution! Disconnect and lockout power supply before making any adjustments or alignments.

Adjustment of Table Top Parallel to Arm

The arm tracks must be parallel to the tabletop at all points. This assures uniform depth of cut, especially when dado cutting. Remove the blade and insert an arbor wrench or allen wrench between the saw arbor collars. Lower the wrench until it touches the tabletop. If the top is not level:

1. Locate the highest point by swinging the arm from side to side and moving the carriage back and forth on the arm.
2. Loosen the lock nuts beneath the table frame.
3. Raise the jack screws so as to bring the low parts of the tabletop level with the high spots.
4. Tighten the lock nuts beneath the table frame.

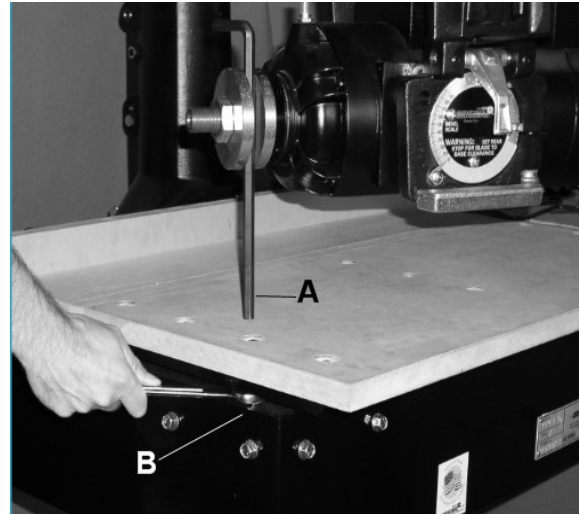

Square the Saw Travel with the Guide Strip

Engage the miter latch, miter clamp and column clamp. Place a steel square against the guide strip, flat on the tabletop. If the blade does not move parallel to the square as the carriage is moved forward the following adjustments are in order:

1. Pull miter handles (A) forward.
2. Loosen the two set screws (B) on the bottom of the rear of the arm that lock the bronze miter latch adjusting screws (C).
3. If the blade moved **toward the square** when pulled, loosen the adjusting screw on the right and tighten the one on the left (as viewed from the front). If the blade movement was **away from the square** then tighten the adjusting screw on the right and loosen the left.
4. Tighten the two locking set screws to a required torque of 200– 225 inch/lbs.
5. The miter latch must have no side play after adjusting.
6. Make a final check of square with the column clamp, miter latch and miter clamp engaged.

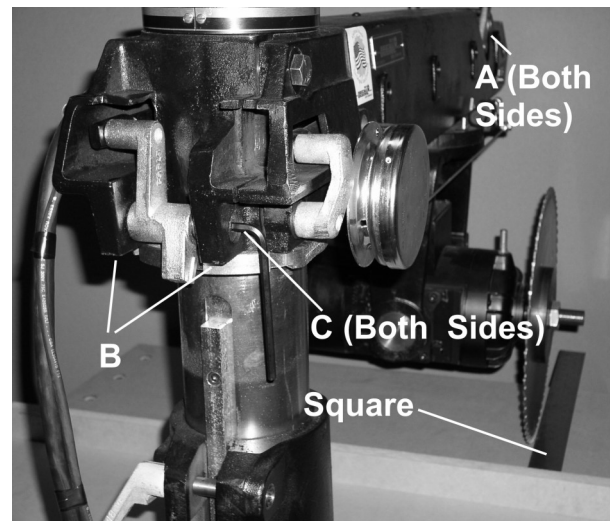

How to check the Guide Strip For Accuracy

For accurate work the guide strip must be straight. If the machine has been exposed to the weather or used for a period of time the wood parts may become warped or worn so that the guide strip is no longer straight. It should be replaced with a straight one. Check it with a straight edge or square before proceeding and make any adjustments necessary.

Caution! Disconnect and lockout power supply before making any adjustments or alignments.

Maintenance Adjustments and Alignments

To Square Saw Blade with the Table Top

Make sure the tabletop is level and place a steel square against the side of the blade; the square should be against the gullets and not the teeth of the blade. If the blade is not square to the tabletop:

1. Release the bevel clamp handle (A) and bevel latch (B).
2. Loosen the two set screws (C) in the front of the yoke locking the bronze bevel latch adjustment screws. (D).
3. Adjust the bevel latch adjustment screws by backing off one and tightening the other to move the blade flush to the square. Tighten the two locking set screws to a required torque of 90-100 inch/lbs.
4. After adjustment, the bevel latch should move freely but with no side play.
5. Engage the bevel latch and bevel clamp and recheck for square.
6. Adjust the bevel pointer (E) to line up with zero on the bevel scale.

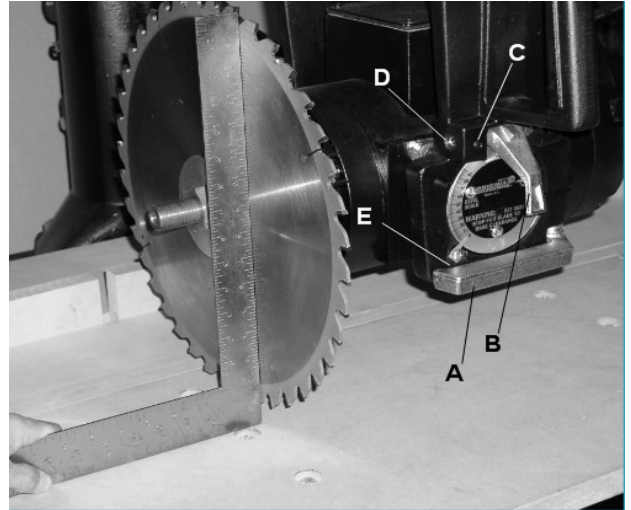

Adjustment of Rear Trunion and Bevel Clamp Handle

If the rear motor trunion is loose in the yoke, or if bevel clamp will not hold:

1. Loosen locking set screws (A in Figures 5 and 6) and bevel clamp (B in figure 5).
2. Tighten rear trunion pinch bolt socket head cap screw (B, figure 6) until bevel movement becomes slightly difficult and requires force to move. Reset its locking set screw to a torque of 90—100 inch/lbs.
3. Tighten the bevel clamp stud (C in figure 5).
4. Tighten its locking set screw to 90-100 inch/lbs.

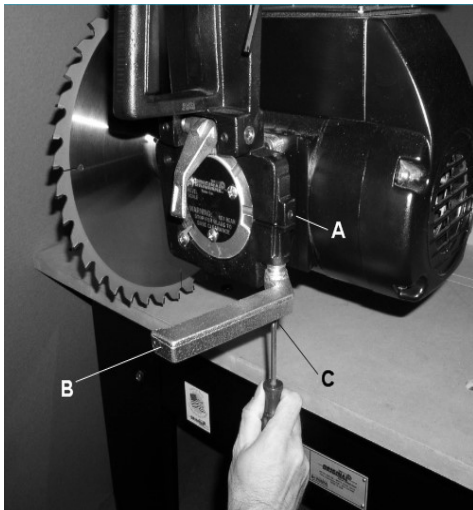

Figure 5

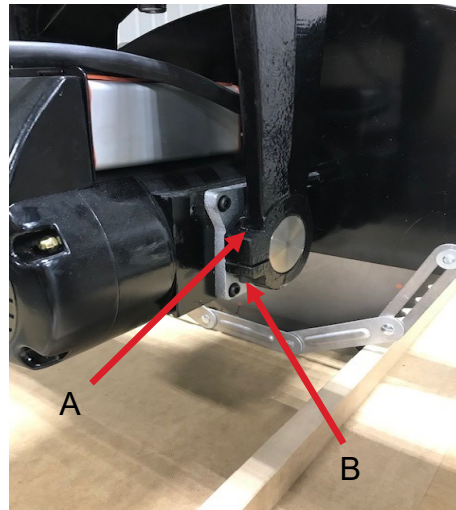

Figure 6

!!! CAUTION !!!

FOR ILLUSTRATION PURPOSES ONLY, THE GUARDS HAVE BEEN REMOVED FOR THE PHOTOS USED IN THIS MANUAL. IN ACTUAL USE OF BOTH UPPER AND LOWER GUARDS MUST REMAIN IN PLACE FOR SAFE CUTTING OPERATION.

Maintenance Adjustments and Alignments

Caution! Disconnect and lockout power supply before making any adjustments or alignments.

Adjustment of Miter, Bevel and Swivel Latches

If a loose condition ever develops between the miter, bevel or swivel latches and their respective adjusting screws, refer back to the following sections for adjustment. Miter Latch, Bevel Latch, Rip Swivel Latch (Figure 7). Be sure to check alignment after adjusting latches.

To Adjust for “Heel” (Saw Blade Not Parallel to Arm)

When the saw blade is not parallel to the arm the result will be what is called “heel” - the back of the blade will not follow in the kerf of the front of the blade. Signs of a blade heeling are indicated when the rear teeth of the blade mark the material with an offset in the cut. This condition can be noticed by eye or with a straight edge. (Figure 6A) To correct this situation:

1. Put the motor into 0° bevel position. Engage bevel latch (A, Fig. 7) and bevel clamp (B).
2. Cross cut a piece of material and determine the side of the cut on which the teeth are heeling. Make a note which side of the cut material has heeling marks.
3. Loosen yoke clamp nut. (C, Fig. 7)
4. Release the rip swivel latch (D, Fig. 7).
5. Loosen the two set screws (E, Fig. 7) locking the bronze rip swivel latch adjusting screws (F, Fig. 7).
6. If the heel marks were on the right side of the material loosen the adjusting screw on your left and tighten the one on the right. If the marks were on the left of the material loosen the adjusting screw on your right and tighten the one on your left.
7. Tighten the two locking set screws to a required torque of 90—100 inch/lbs.
8. The rip swivel latch must move freely without side play.
9. Engage rip swivel latch and lock the yoke clamp, recheck the crosscut and make additional adjustment if necessary.
10. Set a square in the corner of table and fence on left side, place square at a 45° angle it should touch the bottom edge of blade and top edge of blade. (not touching carbides.) Figure 6A



Figure 6A



Figure 6B

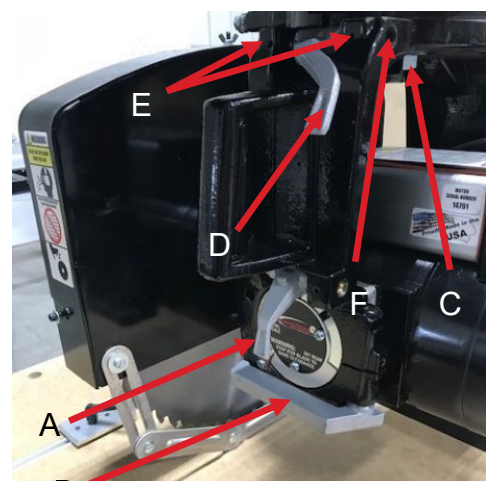
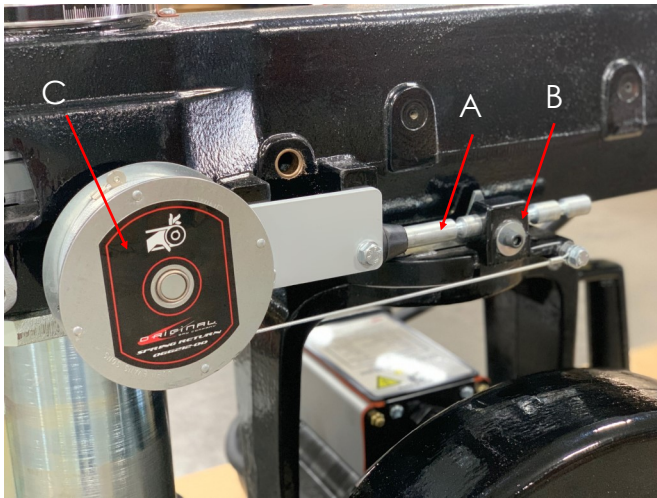

Figure 7

Maintenance Adjustments and Alignments



Bevel Stop Rod



The bevel stop rod (A) is a device mounted on the rollerhead to prevent the blade from contacting the base when the bevel cuts are being made; particularly with 20" blades. A socket head cap screw (B) locks the rod into position. **BEFORE MAKING BEVEL CUTS ALWAYS BE CERTAIN THE BEVEL STOP ROD IS POSITIONED SO THE BLADE CLEARS THE BASE WITH THE MOTOR IN ITS REAR POSITION.**

Carriage Return

The carriage return spring 'C' can be tightened or loosened depending on your preference. To tighten extend out the cable while holding the reel with the left hand and wrap the excess cable around the reel. To loosen unwrap one round of cable.

Adjustment of Miter Scale

The miter scale is located at the rear of the arm. When the arm is positioned for straight cross cutting, the pointer should be a 0° on the scale. To adjust, loosen the screw holding the pointer and adjust to 0°. Retighten the screw.

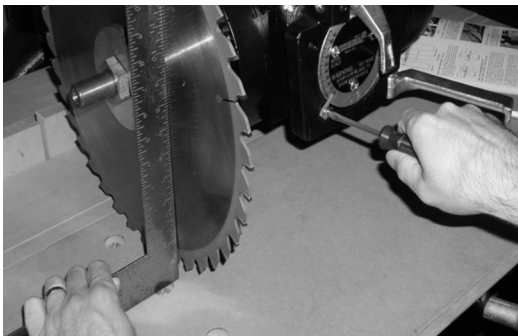

Adjustment of Bevel Scale

The bevel scale is located at the front of the yoke. When the motor is positioned for straight cross cutting the pointer should be at 0° on the scale. To adjust, loosen screw and move pointer to 0° and tighten.



Changing the Motor Voltage

WARNING—DISCONNECT AND LOCKOUT POWER BEFORE SERVICING

If your machine requires a different voltage, follow the instructions below. The motor will need to be rewired according to the diagrams below. The thermal overloads must be reset or replaced with the proper pieces to maintain thermal motor protection.

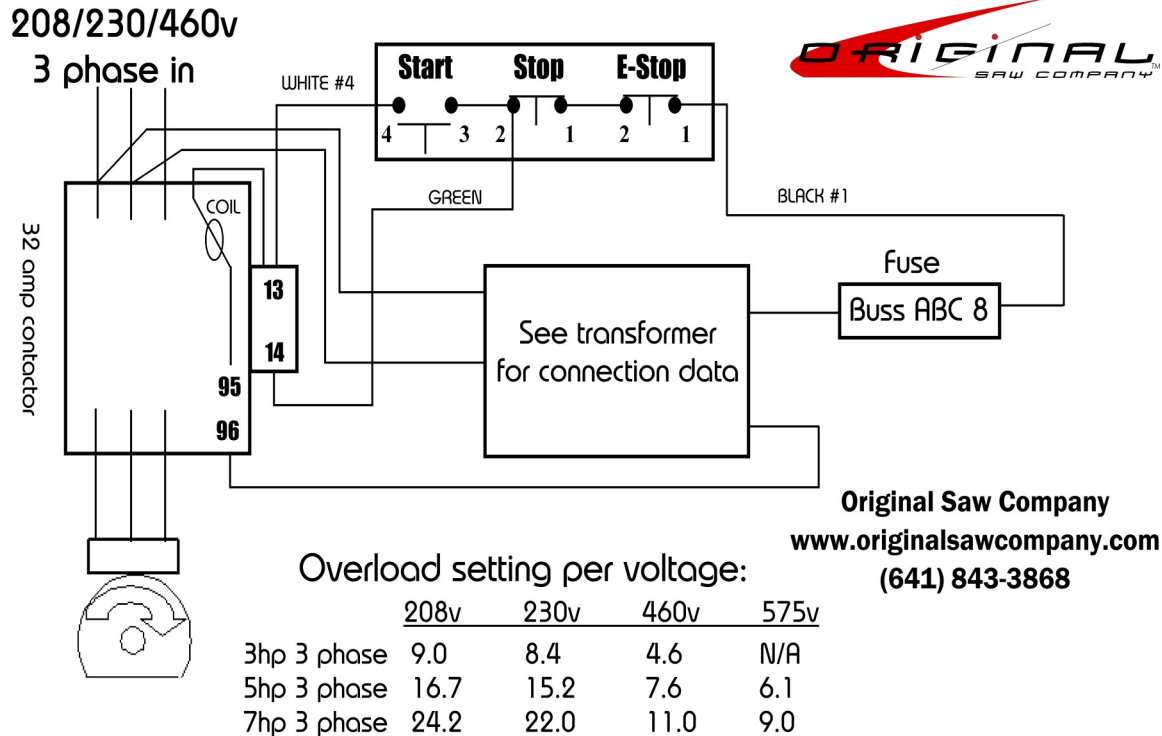

Motor lead wiring diagram

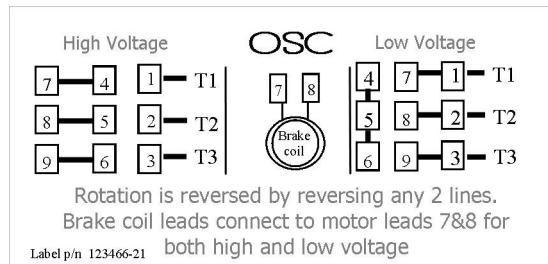

Instructions for Changing the Motor Voltage

- 1) **Disconnect and lockout power**– Electrical shock could occur if this is not done.
- 2) Reconnect motor and transformer leads as shown in the chart above to match your required voltage. Paying careful attention to make sure the brake coil lines are still attached to motor leads #7 and #8.
- 3) Reset the dial for the proper amperage setting shown in the chart above. If your overload block does not have the proper settings, the block will have to be replaced with one appropriate for your voltage.
- 4) Recheck all connections and replace lids on the motor box and magnetic starter enclosure before restoring power.



VFD Wiring Diagram



WARNING—DISCONNECT AND LOCKOUT POWER BEFORE SERVICING

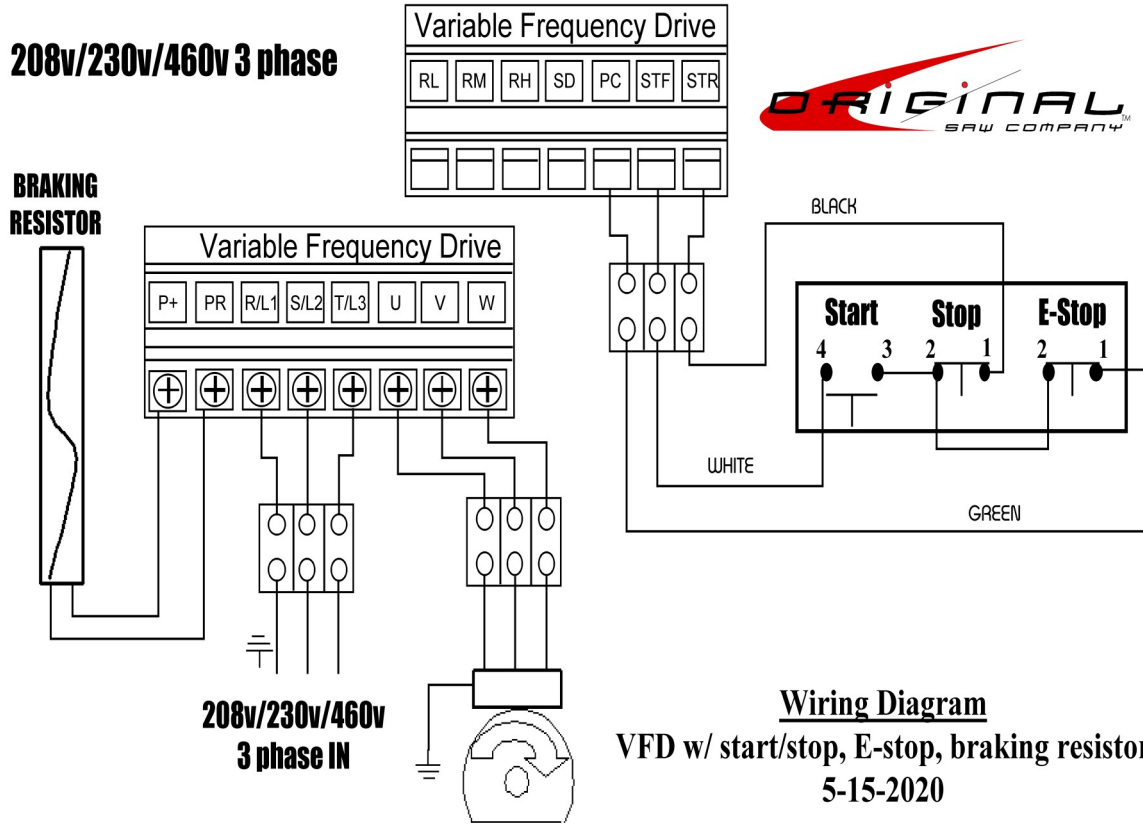

VFD Arbor Rotation

This is usually set from the factory but in certain cases if rotation needs switched, you can change any 2 of the motor lead wires. Changing incoming power leads will not change rotation. (Usually U and V)

Alignment Guide for Accurate Cutting

The following guide is provided for your convenience. A saw that is not properly adjusted will not yield the desired accuracy and quality of cut. It should be noted any adjustment made will effect another, therefore it is best to perform all of the adjustments when correcting any one problem.

PROBLEM	POSSIBLE CAUSE	SOLUTION
Saw will not make a square cross cut or a good 45° miter cut	<ul style="list-style-type: none"> - Arm is not perpendicular to guide fence - Arm has excessive play at end - Column is loose in base - Too much play between arm and column - Rollerhead loose in arm (left to right play) - Yoke loose when clamped to rollerhead - Sawdust between lumber and guide fence - Table not parallel with arm - Guide fence not straight/rear edge of fixed board not straight 	<ul style="list-style-type: none"> - Adjust cross cut travel with guide fence (p. 28) - Tighten adjusting screws - Make proper adjustment (p. 24) - Make proper adjustment (p. 25) - Adjust rollerhead (p. 25) - Adjust yoke clamp handle (p. 26) - Clean tabletop - Make proper adjustment (p. 26,28) - Replace fence/sand or replace (p. 26)
Lumber has a tendency to walk away from fence when ripping or ploughing	<ul style="list-style-type: none"> - Saw blade is not parallel with fence - Arm not perpendicular to guide fence - Dull blade or cutters 	<ul style="list-style-type: none"> - Make heel adjustment (p. 28) - Adjust crosscut travel with guide fence (p. 28) - Sharpen or replace blade
Saw stalls when ripping or ploughing	<ul style="list-style-type: none"> - Fence not straight - Feed rate too fast - Wrong blade - Column too loose in base - Too much play between arm and column - Rollerhead loose in arm - Yoke loose when clamped to rollerhead - Sawdust between lumber and fence 	<ul style="list-style-type: none"> - Replace fence - Slow feed rate - Use correct blade - Make proper adjustment (p. 24) - Make proper adjustment (p. 24) - Make proper adjustment (p. 25) - Make proper adjustment (p. 25) - Clean tabletop
Saw blade scores lumber, finish cut is not smooth	<ul style="list-style-type: none"> - Saw blade is heeling - Column too loose in base - Too much play between arm and column - Rollerhead loose in arm - Yoke too loose when clamped to rollerhead - Bent or dull blade - Not feeding saw properly - Using improper blade 	<ul style="list-style-type: none"> - Make heel adjustment (p. 28) - Make proper adjustment (p. 24) - Make proper adjustment (p. 24) - Make proper adjustment (p. 25) - Make proper adjustment p. 25) - Replace blade - Draw blade across lumber with slow steady pull - Change blade.

PROBLEM	POSSIBLE CAUSE	SOLUTION
Saw blade or dado blades tend to push lumber to one side when cross cutting	<ul style="list-style-type: none"> - Saw blade is heeling - Column too loose in base - Too much play between arm and column - Rollerhead too loose in arm - Yoke too loose when clamped to rollerhead - Fence not straight - Dull blade or cutters 	<ul style="list-style-type: none"> - Make heel adjustment (p. 28) - Make proper adjustment (p. 24) - Make proper adjustment (p.24) - Make proper adjustment (p. 25) - Make proper adjustment (p. 25) - Replace fence - Replace or sharpen
Cut depth varies from one end of stock to the other	<ul style="list-style-type: none"> - Tabletop not parallel with arm - Column too loose in base - Too much play between arm and column 	<ul style="list-style-type: none"> - Adjust tabletop to arm (p. 26) - Make proper adjustment (p. 24) - Make proper adjustment (p. 24)
45° bevel cut not accurate	<ul style="list-style-type: none"> - Saw blade not perpendicular to tabletop - Column too loose in base - Too much play between arm and column - Rollerhead too loose in arm - Yoke too loose when clamped to rollerhead - Bevel clamp handle loose - Tabletop not parallel to arm 	<ul style="list-style-type: none"> - Make proper adjustment (p. 26) - Make proper adjustment (p. 24) - Make proper adjustment (p. 24) - Make proper adjustment (p. 25) - Make proper adjustment (p. 25) - Make proper adjustment (p. 27) - Make proper adjustment (p. 26)
Saw tends to advance over lumber too fast	<ul style="list-style-type: none"> - Rollerhead bearings out of adjustment - Dull blade - Not feeding saw properly 	<ul style="list-style-type: none"> - Adjust bearings (p. 25) - Replace or sharpen blade - Draw blade across lumber with a slow steady pull
Saw does not move smoothly in arm tracks	<ul style="list-style-type: none"> - Dirty tracks - Bad bearing 	<ul style="list-style-type: none"> - Clean tracks - Replace bearing
Miter scale not accurate at various miter angles	<ul style="list-style-type: none"> - Scale pointer not properly adjusted 	<ul style="list-style-type: none"> - Adjust scale pointer
Elevating handle slips when elevating or lowering the saw	<ul style="list-style-type: none"> - Base not adjusted properly 	<ul style="list-style-type: none"> - Adjust base to column (p. 24)
Clamping force not sufficient at miter angles other than 45°	<ul style="list-style-type: none"> - Arm clamp out of adjustment 	<ul style="list-style-type: none"> - Adjust arm clamp (p. 24)
Clamping force not sufficient at bevel angles other than 45°	<ul style="list-style-type: none"> - Bevel clamp handle too loose 	<ul style="list-style-type: none"> - Adjust bevel clamp (p. 27)

ELECTRICAL TROUBLE-SHOOTING GUIDE

CAUTION—HIGH VOLTAGES ARE DANGEROUS—BE SURE POWER IS OFF AND LOCKED OUT WHEN INSPECTING OR REPAIRING MOTOR OR CONTROLS

TROUBLE	POSSIBLE CAUSE	SUGGESTED REMEDY
Saw motor will neither start nor hum	Power line not connected to cable.	Correct power wiring. See wiring diagram inside magnetic starter box.
	Thermal overload relays may have tripped.	Allow time for overload relays to cool.
	Faulty (brown) line fuse, line circuit breaker tripped.	Check for presence of proper voltage at motor.
	Defective control transformer.	Check circuit with continuity meter. Ensure power is off.
	Start and stop switches at end of arm may be defective.	
	Faulty starter.	
Saw motor hums but will not start (Shut off power immediately)	Open circuit in a thermal relay heater.	Remove heaters. If defective, heater may be completely burned up. Install new heater if required.
	Open circuit in motor cable or cable lugs.	Use a continuity meter and check each wire between control unit and motor. Check lug connections.
	Wiring error.	Check connections in starter box and conduit box, refer to motor and starter connection diagrams.
	Mechanical binding—shaft should turn freely by hand.	Tap end of shaft with mallet to seat bearings in end bells. Check bearings and bell etc. Replace as needed.
	Low voltage—voltage should be measured at the motor while it is starting and blade attached. Voltage should not drop lower than 185 volts for 208, 220 and 230 volt systems.	Check for loose or high resistance connections— make sure lines are of ample capacity and other equipment is not pulling down the voltage.
	Burned out stator	If motor smells or has been smoking each phase winding should be checked with a test lamp or continuity meter.
	Bad capacitor (single phase only).	Turn off power, remove motor nameplate. Discharge capacitor by short circuiting terminals; remove motor from circuit. Test with ohm meter. Needle should jump when leads are touched to capacitor terminals and fall back to a high resistance as capacitor charges.
	Bad starting relay (single phase only).	If contacts are excessively burned, pitted or welded together the relay must be replaced. Check for open relay coil using continuity meter.
Motor trips overload relay or blows line fuse.	Wrong heater or fuse.	Replace with proper heater, fuse or circuit breaker.
	Excessive currents.	Check for grounds or shorts.
	Low voltage.	Check voltage while starting as outlined above.
	Loose or faulty connection.	Locate and repair.

Intentionally left blank



IMPORTANT

IMPORTANT

IMPORTANT

To assure product reliability, repairs, maintenance and adjustments should be performed by Authorized Service Centers, always using genuine replacement parts.

For parts or service please contact Original Saw for the dealer nearest you.



465 Third Ave SE
P.O. Box 331
Britt, IA 50423
PH 800/733-4063 641-843-3868
FX 641 / 843-3869
E-mail customerservice@originalsaw.com
www.originalsaw.com

Printed in the USA © The Original Saw Company 03/2020 Super Duty Series Type 10
(6/19/2020) Updated product spec sheets cew